

Product and Service Offering	1	Floor Diffusers & Grilles	16-20
Residential Product Guide	2-4	Designer Collection	21-23
Ceiling Diffusers	5-7	Accessories	24
Evaporative Diffusers	8-9	Residential Engineering Data.....	E1-E25
Return Air Grilles	12	Return Air Sizing Chart.....	E2
Filter Grilles	13	Alternate Size Chart	E3
Baseboard Registers.....	14-15	Cross Reference Guide.....	E26-E27
.....		Product Index / Glossary of Terms	E28

PRODUCT & SERVICE OFFERING

FINISH

All Shoemaker registers and grilles have baked-on textured polyester powder paint. Shoemaker standard finishes are (A) Soft White and (B) Driftwood Tan. This finish will resist peeling, cracking, chipping and fading after application and through shipping, handling, installation. The quality and durability of this finish is long-lasting, an advantage over other finishes that require touch-up.

The following finishes are available on specified products at an additional cost:

- (C) Designer Colors *
- (D) Custom Plating **
- (E) Classic Wood Oak ***
- (F) Satin Anodized
- (H) Bronze Paint
- See page 21 for color charts

* **Designer Colors:** Navajo White, Forest Green, Burgundy, Camaro Silver, Bronze, Royal Blue, Coffee Tan, Almond, Black Velvet, Vanilla
 ** **Plating:** Polished Brass, Antique Brass, Polished Chrome, Copper, Pewter, Satin Nickel, Black Nickel, Oil Rubbed Bronze, 24 Carat Gold
 *** **Classic Wood Oak:** Self-rimming style standard in natural Red Oak with lacquer finish. Choose from honeycomb & louvered face styles; flush, rabbeted and baseboard installation styles; and different wood species.

PRODUCTION

Lead Times: Orders are entered immediately upon receipt and will ship in a timely manner. Lead times vary according to quantity and product mix.

Back Orders: Shoemaker is committed to completely satisfying all orders and for the customer to receive all line items in an order. Exceptions to this include certain plated and wood products which are out of our manufacturing control. **Shoemaker does not backorder.** * * Certain products and quantities do not apply. See product ordering notes in pricing catalog for further information.

Expedited Services Program: Most products in this catalog can be manufactured and shipped from same day up to five working days after receipt of order. Certain products and quantities do not apply. See product ordering notes in the **Pricing Catalog** for further information. Expedited Service orders are processed immediately and cannot be cancelled.

Shipping Methods: Shoemaker shipping services include Parcel Ground, Parcel Next Day, Parcel 2nd Day, Parcel 3rd Day Select, Federal Express and LTL Motor Freight.

Palletizing: Shoemaker products are palletized and shrink wrapped whenever possible. Product grouping is not limited. There is no extra fee for this service.

GUARANTEE

All Shoemaker products come with an unconditional guarantee to be free from defective material and workmanship under normal service and use for which they were designed. Shoemaker will repair or replace (free of charge) any defective product or part(s). However, Shoemaker is not responsible for any peripheral costs including, but not limited to, cost of removal and replacement, liabilities, lost profit, loss of goodwill, or any other general, special, incidental or consequential damages incurred in connection with the purchase of Shoemaker products. The warranty on the finish surface of the Shoemaker Designer Collection of wood, custom plated finish and/or custom painted registers, grilles and diffusers is for a period of 90 days and includes defects in material and workmanship (under normal service.)

RESPONSIBILITY

Shoemaker’s responsibility ceases when the carrier signs for the shipment in good order. In case of loss, visible or concealed damage, the customer as consignee must report such loss or damage at once with the carrier. Shoemaker verifies shipment date and pro number by fax via the Shipping & Receiving Document. This document assists the customer in verifying complete shipments along with any possible damage that occurred during shipping.

DISCLAIMER

We reserve the right to make changes to the product, product specifications, and packaging without notice.

CANCELLATIONS

24 hours after receipt of an order, cancellations or changes may not be approved pending status of work in process.

PRICING

For product pricing refer to index on back page of current Product Price List.



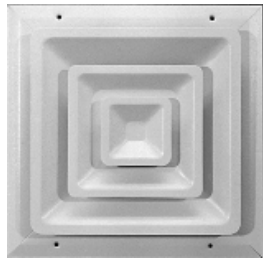

100
4-Way Fixed Core
Step Down
Ceiling Diffuser
PAGE 5



400
4-Way Ceiling Box
Swamp Cooler
Diffuser
PAGE 8



150
4-Way
Stamped Face
Ceiling Diffuser
PAGE 5

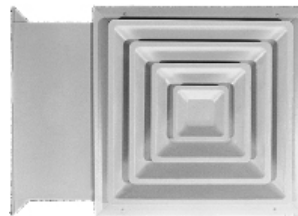

425
Step Down 4-way Swamp
Cooler Ceiling Diffuser
with Slide-in Damper
PAGE 8



SDD
Square Ceiling
Directional Diffuser with
Flush Fixed Core
PAGE 6



SCB
Steel Adjustable
Curved Blade
Diffuser
PAGE 7



90
Round
Step down
Ceiling Diffuser
PAGE 6



845
3-way
Stamped Face
Ceiling/Sidewall Diffuser
PAGE 10



200
Stamped
Curved Blade
Ceiling Diffuser
PAGE 7

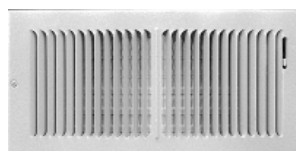

850
1/2" Spacing
2-way Stamped Face
Ceiling/Sidewall Diffuser
PAGE 10



945
Multi-directional Diffuser
with Multi-Shutter or
Opposed Blade Damper
PAGE 11



FG
Sidewall/Ceiling
Stamped Face
Filter Grille
PAGE 13

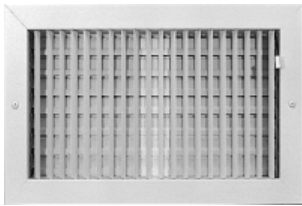

951
Single Deflection Diffuser
with Multi-Shutter or
Opposed Blade Damper
PAGE 11



855
All Steel
Baseboard Register with
Multi-Shutter Damper
PAGE 14

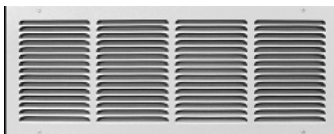

1050 & 1075
1/2" Spacing
Sidewall/Ceiling
Return Air Grille
PAGE 12



955
Extruded Aluminum
Baseboard Register with
Multi-Shutter Damper
PAGE 14



875
Baseboard
Diffuser
PAGE 14

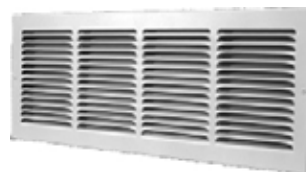

1150
1/2" Spacing
Baseboard
Return Air Grille
PAGE 15



920FG
Sidewall/Ceiling
Filter Grille
PAGE 13



1100
Aluminum Baseboard Re-
turn Air Grille
with 45° Fixed Blades
PAGE 15



350
Stamped Face
Perimeter
Floor Diffuser
PAGE 16



**Designer Series
Colors**
Stamped Face Perimeter
Floor Diffuser in
10 distinctive colors
PAGE 21



375
Fabricated
Deluxe Floor
Diffuser
PAGE 16



**Designer Series
Wood Oak**
Self-Rimmed
350 Series
PAGE 22 & 23



TS
2 1/4" & 4"
Toe Space
Grille
PAGE 17



AFP
Extruded Aluminum
Perimeter Floor
Diffuser
PAGE 17

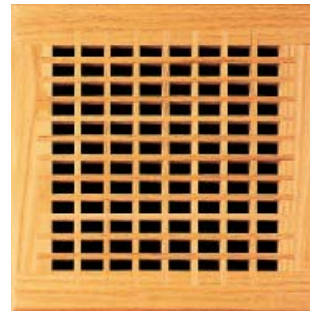

Designer Series
Floor & Sidewall Grilles in
Designer Colors, Brass,
Chrome and Wood
PAGE 21, 22 & 23



1550
Honeycomb Construction
Fabricated Floor
Supply Register
PAGE 20



Ornamental Series
Cast Iron Ornamental
Registers in Designer Colors
and Solid Cast Brass
PAGE 23

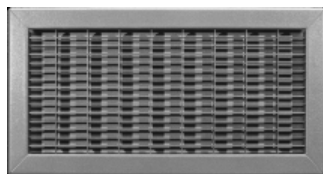

1600
Honeycomb Construction
Fabricated Floor
Return Air Grille
PAGE 20



No Labor Collar
PAGE 24

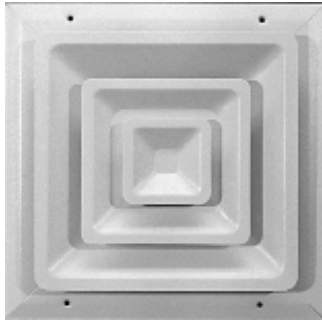

100 Series Step Down Ceiling Diffuser

- Step-down core design
- Four-way air diffusion
- Countersunk mounting holes for flush appearance with color matching Phillips posi-drive screws
- Step down feature allows for uniform airflow distribution
- Variations:
 - 100 – diffuser less damper
 - 100 D – diffuser with steel multi-shutter damper
 - 100 O – diffuser with steel lever operated opposed blade damper

• Soft White

Optional:

- Square to round no labor collar (see page 24)
- Finishes B & C (see page 21)

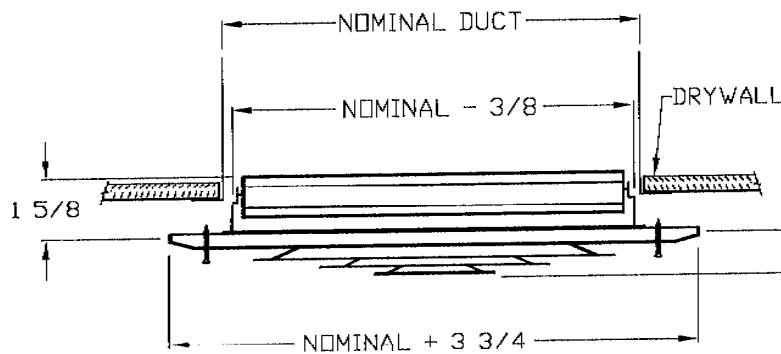

Size	Dimension "A"
6	1 1/4
8	1 1/4
10	1 1/2
12	2
14	2 3/4
16	2 3/4
18	3
20	3
24	3 1/4

For Engineering information see page E4.



150 Series 4-Way Ceiling Diffuser

- Louvered with stiffened 1/2" blade for silent operation
- Standard multi-shutter damper
- All component parts, rivets, linkage and handle are enclosed in the valve to assure trouble-free operation
- Countersunk mounting holes for flush appearance, with color matching Phillips posi-drive screws

• Soft White

Optional:

- Steel Lever operated Opposed blade damper (150 O)
- Finishes B, C & D (see page 21)
- Square to round no labor collar (see page 24)
- Series 151 - Grille only

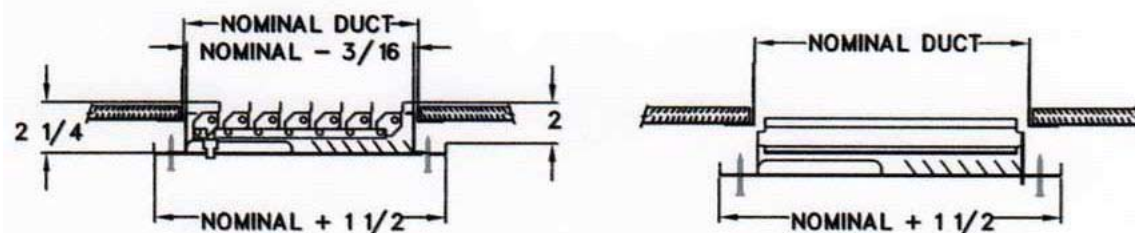

For Engineering information see page E8.



SDD Series

Square Ceiling Directional Diffuser

- Fixed steel cores
- Steel frame
- Five different air patterns
- Countersunk mounting holes for flush appearance with color matching Phillips posi-drive screws
- All component parts, rivets, linkage and handle are enclosed in the valve to assure trouble-free operation
- Variations:
 - SDD** - Diffuser less damper
 - SDD-D** - Diffuser with steel Multi-shutter damper
 - SDD-O** - Diffuser with steel Opposed Blade damper
- Available in square sizes 6x6 thru 16x16
- Soft White

Optional:

- Square to round No Labor Collar (see page 24)
- Finishes B & C (see page 21)
- Tamper proof screws (see page 24)

CORE PATTERN DRAWINGS

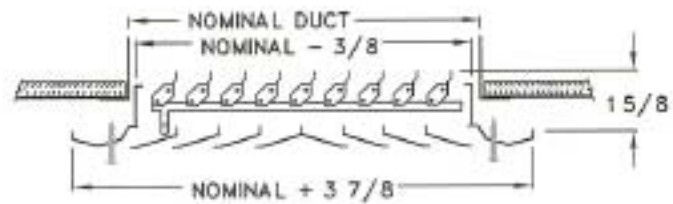
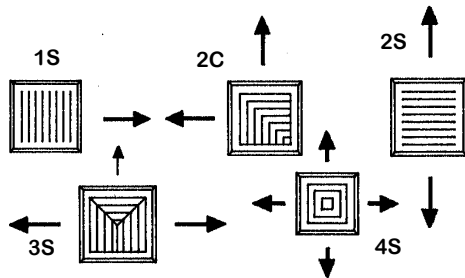

For Engineering information see pages E6, E7.

90 Series

Step Down Round Diffuser

- Ideal for residential and light commercial application
- All steel construction
- Attractive concentric ring deflects air stream 360°
- Soft White

Optional:

- Finishes B & C (see page 21)



91 Series Round Bowtie Damper

- Field installable bowtie damper with round ring
- Available 6, 8, 10, 12 & 14"
- Mill finish

92 Series Round Ring

- Use in applications for installing round without damper
- All steel galvaneal construction

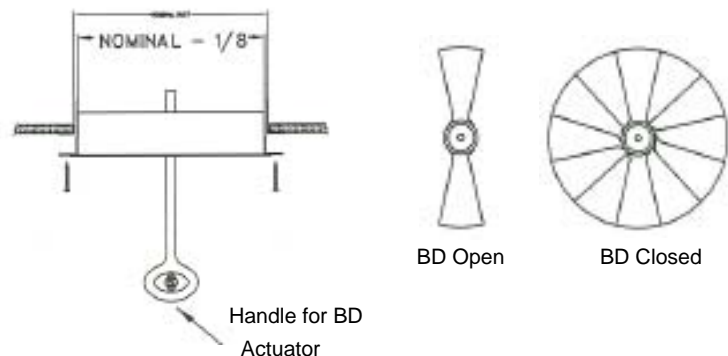
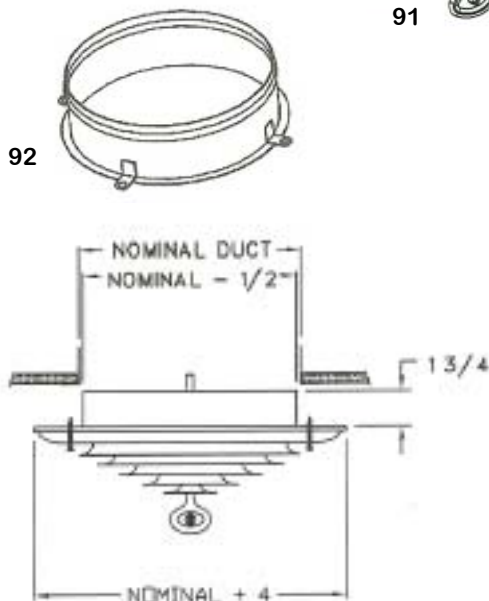

For Engineering information see page E8.

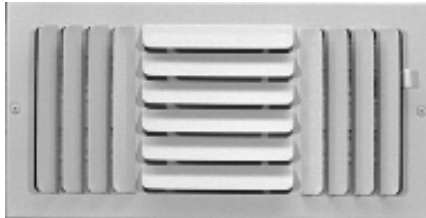

203 SERIES

**200 Series
Ceiling Curved Blade Diffuser**

- Stamped curved blades
 - Field adjustable for positive throws and control of face velocities
 - Provides uniform air distribution across ceiling or walls
 - Choice of eight air patterns
 - All component parts, rivets, linkage and handle are enclosed in the valve to assure trouble-free operation
 - Countersunk mounting holes for flush appearance with color matching Phillips posi-drive screws
 - Standard - Steel Multi-shutter damper
 - Soft White
- Optional:**
- Steel Lever operated Opposed Blade Damper (200-O)
 - Finishes B, C & D (see page 21)
 - Tamper proof screws (see page 24)

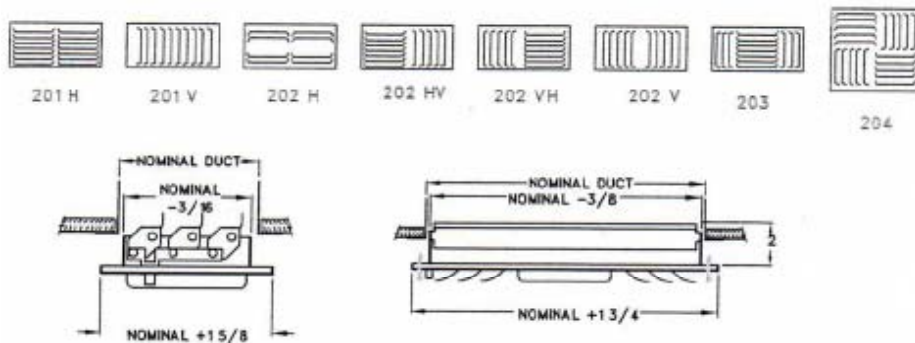

For Engineering information see pages E5.



SCB41 SERIES

**SCB Series
Adjustable Curved Blade Diffuser**

- Individually adjustable steel curved blades
 - Standard with lever operated steel multi-shutter damper
 - Pivoted steel blades for easy firm positioning
 - 4-way air pattern (SCB41)
 - 3-way air pattern (SCB31)
 - All component parts, rivets, linkage and handle are enclosed in the valve to assure trouble-free operation
 - Countersunk mounting holes for flush appearance with color matching Phillips posi-drive screws
 - Soft White
- Optional:**
- Steel Lever operated Opposed Blade Damper (SCB41-O or SCB31-O)
 - NO damper (SCB42 or SCB32)
 - Finishes B & C (see page 21)
 - Tamper proof screws (see page 24)

Note: Other air pattern variations & sizes refer to CB Series

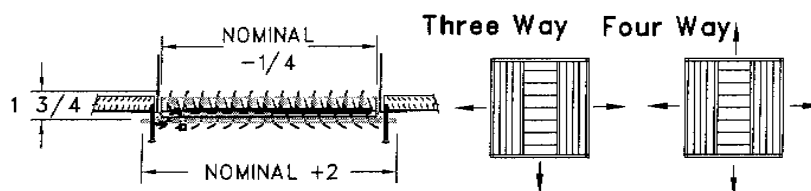

For Engineering information see page E22.



400 Series 4-way Ceiling Diffuser Box

- For large volume air delivery
- For evaporative coolers or central blower systems
- Adjustable directional dampers with shut-off
- Countersunk mounting holes for flush appearance with color matching Phillips posi-drive screws
- Soft White

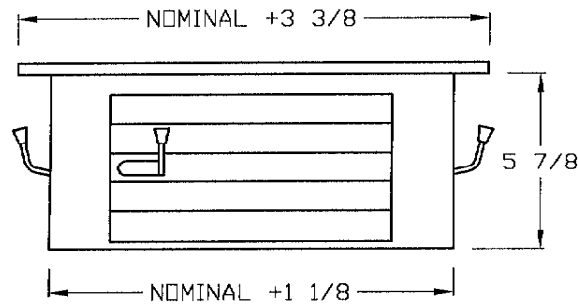

For Engineering information see page E9.

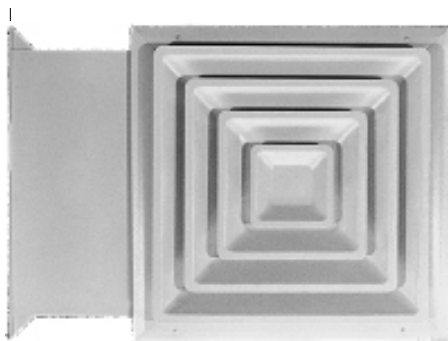

425 Series Step Down Diffuser with Slide-in Damper

- All steel galvaneal construction
- For evaporative coolers or central blower systems
- Modern step-down design
- 4-way air diffusion
- Countersunk mounting holes for flush appearance with color matching Phillips posi-drive screws
- One-piece removable slide damper for off season closure
- Soft White

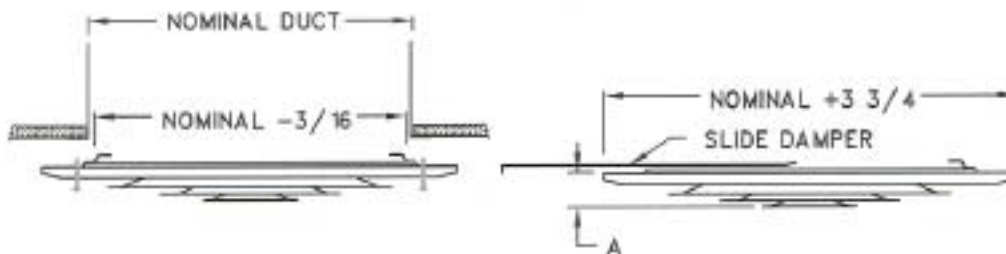

SIZE	DIM. "A"
10	1 1/2"
12	2
14	2 3/4"
16	2 3/4"
18	3
20	3
24	3 1/4"

For Engineering information see page E9.



**450 Series
High-Velocity Multi-Louver
Flush Diffuser**

- For evaporative cooling or high velocity exhaust applications with divided 2-way multi-louver and combination shut-off
- Countersunk mounting holes for flush appearance with color matching Phillips posi-drive screws
- Soft White

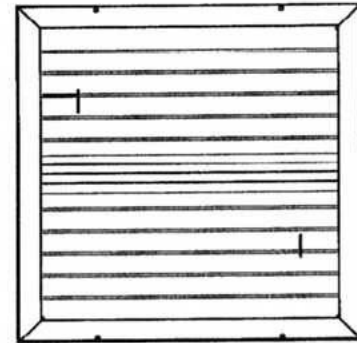
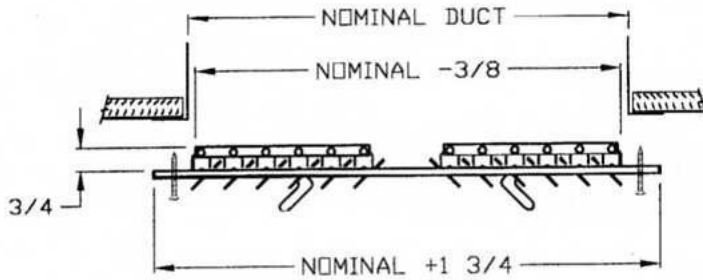

For Engineering information see page E9.



**452 Series
Two Way Curved Blade Diffuser
with Slide-in Damper**

- All steel Galvaneal construction
- Provides uniform air distribution across ceiling
- For evaporative cooling or high velocity exhaust applications
- One piece removable slide-in damper for off season closure
- Countersunk mounting holes for flush appearance with color matching Phillips posi-drive screws
- Ideal for corridor and hallway application
- Soft White

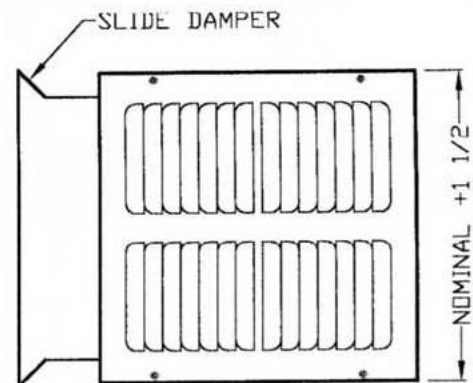
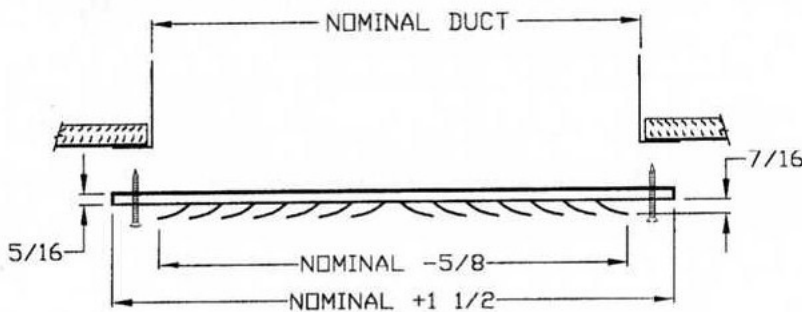

For Engineering information see page E8.

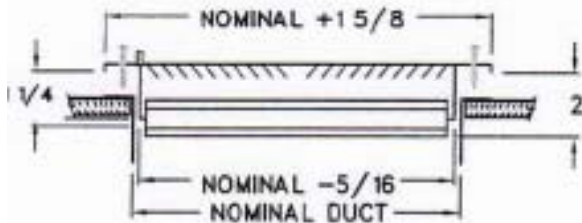
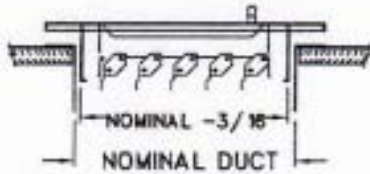
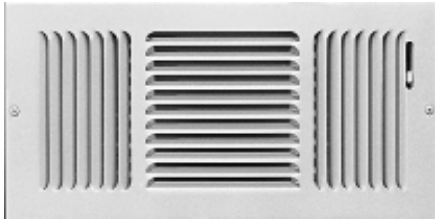

For Engineering information see page E12.

845 Series Diffuser

- 3-way diffusion for draft-free heat or air conditioning
- For ceiling or sidewall applications
- All component parts, rivets, linkage, and handle, are enclosed in the valve to assure trouble free operation
- Countersunk mounting holes for flush appearance with color matching Phillips posi-drive screws
- Standard - Steel Multi-shutter damper
- Soft White

Optional:

- Steel Lever operated Opposed Blade Damper (845-O)
- Finishes B, C & D (see page 21)
- Tamper proof screws (see page 24)

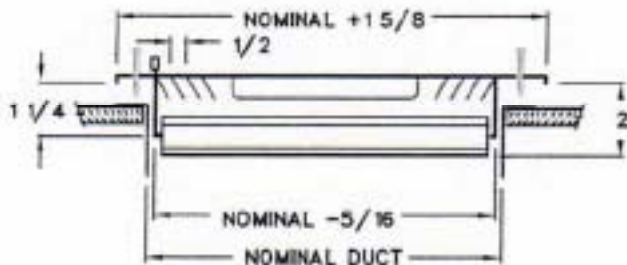
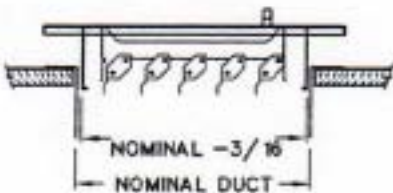
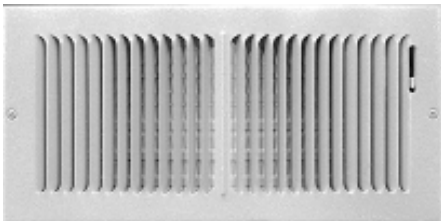

For Engineering information see page E13 and E14.

850 Series Diffuser

- 1/2" Fan-shaped louvers for heating or cooling
- Use in ceiling or sidewall applications
- All component parts, rivets, linkage and handle are enclosed in the valve to assure trouble-free operation
- Countersunk mounting holes for flush appearance with color matching Phillips posi-drive screws
- Standard - Steel Multi-shutter damper
- Soft White

Optional:

- Steel Lever operated Opposed Blade Damper (850-O)
- Finishes B, C & D (see page 21)
- 1/3" spaced louvers (833)
- 1/3" spaced louvers with Opposed Blade Damper (833-O)
- Tamper proof screws (see page 24)



945 Series Adjustable Diffuser

- Adjustable steel face bars with steel multi-shutter damper
- For ceiling or sidewall applications
- Blades fully adjustable for 3 or 4-way air flow pattern
- Vertical & horizontal air deflectors with nylon bushings for easy adjustment and quiet settings
- Countersunk mounting holes for flush appearance with color matching Phillips posi-drive screws
- All component parts, rivets, linkage and handle are enclosed in the valve to assure trouble-free operation
- Soft White

Optional:

- Finishes B & C (see page 21)
- Steel Lever operated Opposed Blade Damper (945-O)
- Tamper proof screws (see page 24)

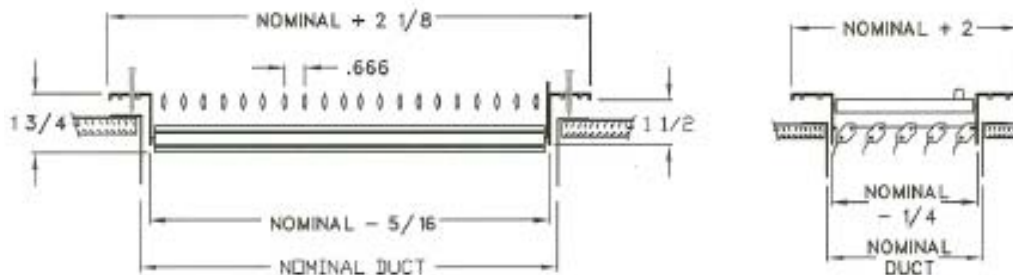

For Engineering information see page E13.

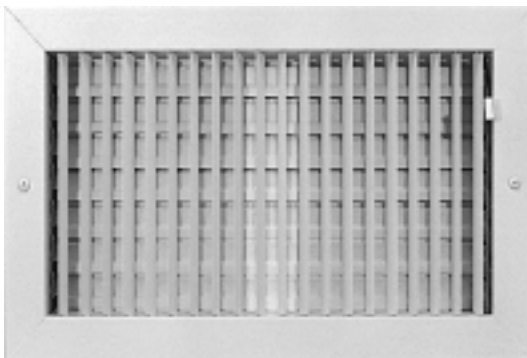

951 Series Adjustable Diffuser

- Adjustable steel face bars with steel multi-shutter damper
- For ceiling or sidewall applications
- Vertical air deflectors with nylon bushings for easy adjustment and quiet settings
- Countersunk mounting holes for flush appearance with color matching Phillips posi-drive screws
- All component parts, rivets, linkage and handle are enclosed in the valve to assure trouble-free operation
- Soft White

Optional:

- Finishes B & C (see page 21)
- Steel Lever operated Opposed Blade Damper (951-O)
- Aluminum airfoil blades (950)
- Tamper proof screws (see page 24)

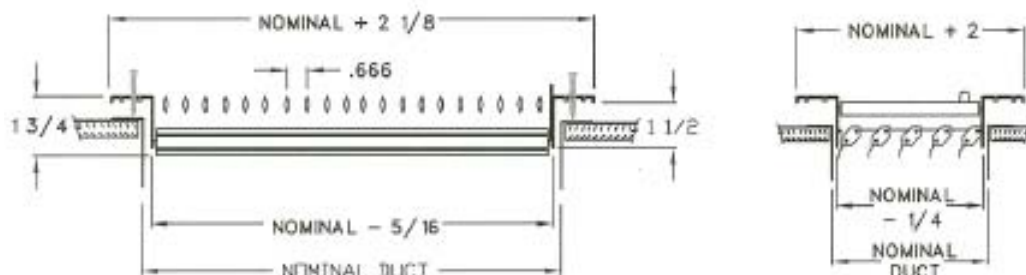

For Engineering information see page E18.

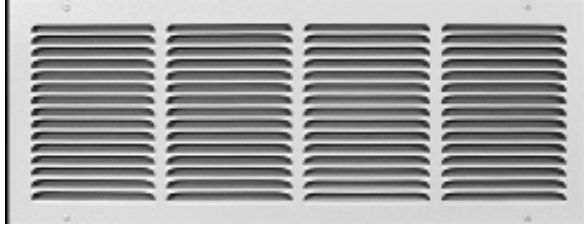

1050 Series Return Air Grille

- 1/2" spacing dual angular louvers
- 22 & 20 gauge cold roll steel
- Install with louvers in up or down position for best duct concealment
- Countersunk mounting holes for flush appearance with color matching Phillips posi-drive screws
- Soft White

Optional:

- Finishes B, C & D (see page 21)
- 1/3" spacing available in limited sizes (**1033**)
- .032 Aluminum construction (**A-1050**)
- Tamper proof screws (see page 24)

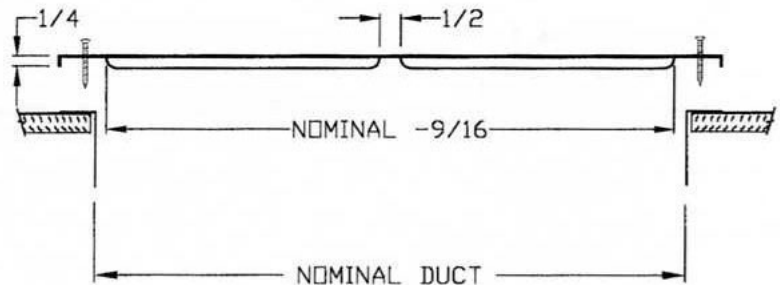
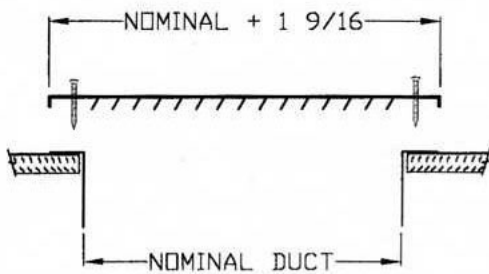

For Engineering information see page E16-17.

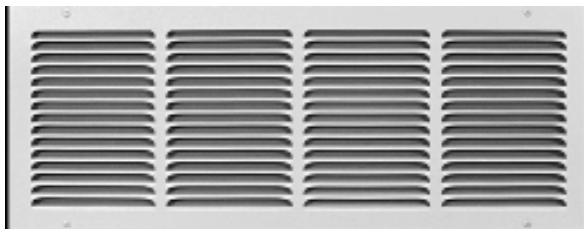

1075 Series Return Air Grille

- 1/2" spacing dual angular louvers
- 22 & 20 gauge cold roll steel
- Mullions are reinforced with stiffeners for greater strength
- For applications where greater air volume is required
- Install with louvers in up or down position for best duct concealment
- Countersunk mounting holes for flush appearance with color matching Phillips posi-drive screws
- Soft White

Optional:

- Finishes B, C & D (see page 21)
- Tamper proof screws (see page 24)

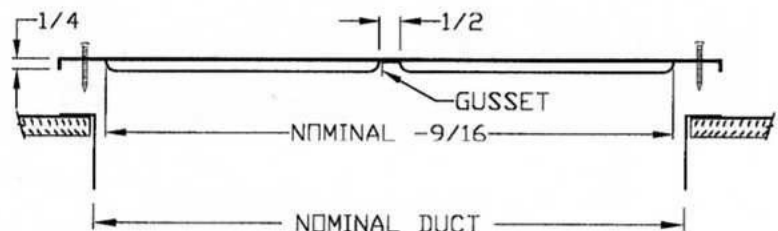
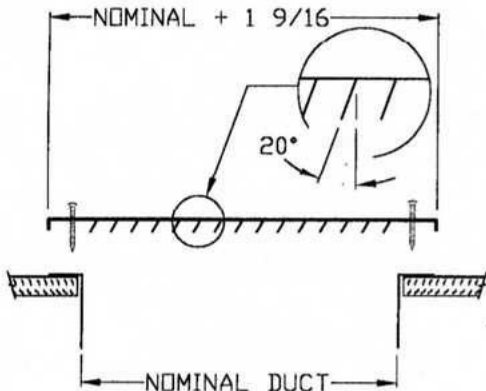

For Engineering information see page E16-17.



FG Series Filter Grille ^{NEW}

- 1/2" spacing dual angular louvers
- 22 & 20 gauge cold roll steel
- Hand operated lever for easy filter access
- 2" thick standard filter (not included). Capable of holding 1" also.
- Removable face for easy cleaning and maintenance
- Filter door hinges parallel to longest side
- 4-way reversible door on square sizes
- 2-way reversible door on rectangular sizes
- Filter retention tabs
- Concealed mounting holes
- Soft White

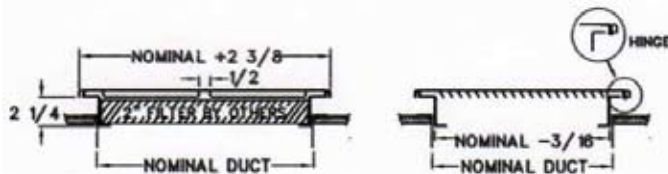

Note: Filter grilles are manufactured 3/16" undersized nominal duct outside dimension for ease of installation. Air filter should be 1/4" to 1/2" undersize. Verify with air filter manufacturer for air filter specification.

Shoemaker filter grilles allow for installation of larger thickness filters that can reduce pressure drop on the overall system which can improve air flow through the heat exchanger and allow more time between filter changes.

For Engineering information see page E20.

Optional:

- Finishes B, C & D (see page 21)
- SPFG-4 houses 4" deep air filter



920 FG Series Fixed Bar Blade Filter Grille ^{NEW}

- 45° fixed blades parallel to first dimension given
- Hand operated lever for easy filter access
- 2" thick standard filter (not included). Capable of holding 1" also.
- Removable face for easy cleaning and maintenance
- Filter door hinges parallel to longest side
- 4-way reversible door on square sizes
- 2-way reversible door on rectangular sizes
- Filter retention tabs
- Concealed mounting holes
- Soft White

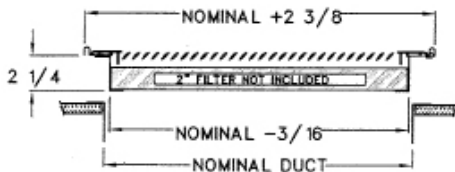

Note: Filter grilles are manufactured 3/16" undersized nominal duct outside dimension for ease of installation. Air filter should be 1/4" to 1/2" undersize. Verify with air filter manufacturer for air filter specification.

Shoemaker filter grilles allow for installation of larger thickness filters that can reduce pressure drop on the overall system which can improve air flow through the heat exchanger and allow more time between filter changes.

For Engineering information see page E20.

Optional:

- Finishes B & C (see page 21)
- SP920FG-4 houses 4" deep air filter

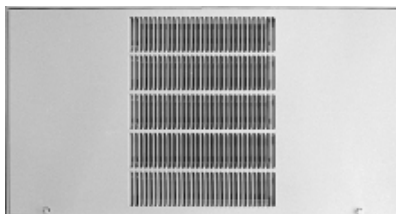

FG/AD Series Filter Grille Access Door

- Dual Angular louvers for strength and maximum free area
 - Hand operated lever for easy filter access
 - Soft White
- Optional:**
- AD Series - Access Door Only

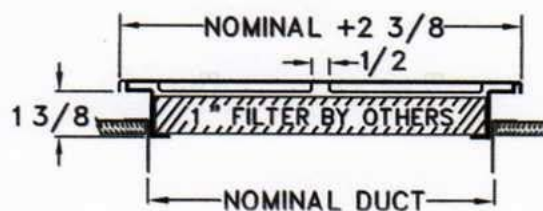

For Engineering information see FG page E20.



855 Series Baseboard Register

- All steel construction
- Fan shaped 1/2" spaced louvers
- Steel Multi-shutter damper
- 7/8" margin turnback
- All component parts, rivets, linkage and handle are enclosed in the valve to assure trouble-free operation
- Soft White

Optional:

- Finishes B, C & D (see page 21)
- Tamper proof screws (see page 24)

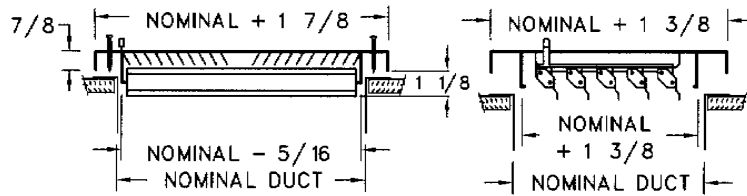

For Engineering information see page E15.



955 Series Baseboard Register

- Extruded aluminum construction with steel multi-shutter damper
- Margin edges are 7/8" projection for baseboard installation
- Nylon bushings for easy adjustment and quiet setting of airfoil blades running parallel to shortest dimension
- Countersunk mounting holes for flush appearance, with color matching Phillips posi-drive screws
- All component parts, rivets, linkage and handle are enclosed in the valve to assure trouble-free operation
- Soft White

Optional:

- Finishes B & C (see page 21)
- Steel Opposed Blade Damper (955-O)
- Tamper proof screws (see page 24)

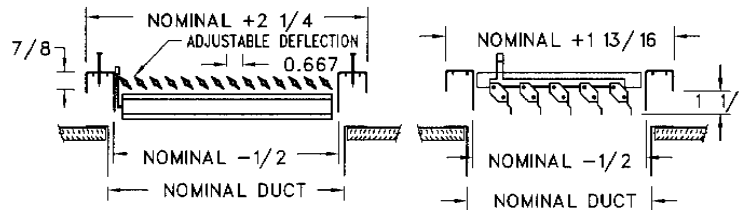

For Engineering information see page E18.



875 Series Baseboard Diffuser

- All steel construction
- Generous free area for quiet operation
- Lever operated single-blade damper
- Removable face and damper
- Tension wings to stabilize damper
- Available in 15", 18" or 24" lengths
- White

Optional:

- Finishes B & C (see page 21)



For Engineering information see page E21



**1150 Series
Baseboard Return Air Grille**

- 1/2" spaced vision-proof dual angular louvers for strength and maximum free area
- Margin edges are 7/8" projection for baseboard installation
- Soft White with color matching screws

Optional:

- 1/3" spaced dual angular louvers (1133)
- Added mullion stiffeners for greater strength (1175)
- Finishes B, C & D (see page 21)

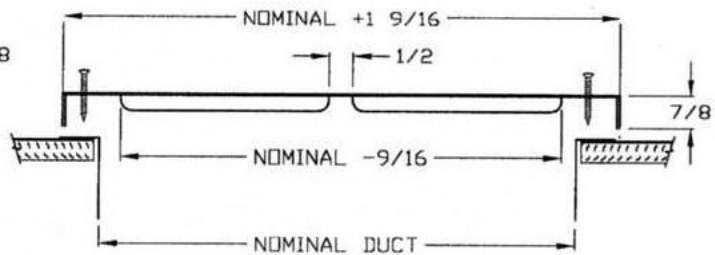
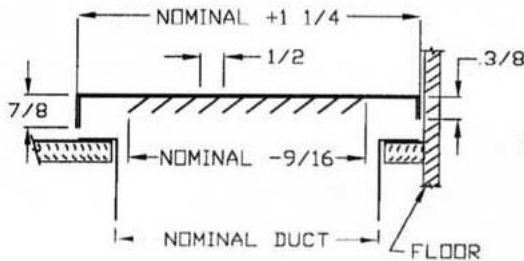

For Engineering information see page E15.



**1100 Series
Baseboard Return Air Grille**

- All extruded aluminum construction
- 45° fixed blades parallel to longest dimension
- Margin edges are 7/8" projection for baseboard installation
- Countersunk mounting holes for flush appearance with color matching Phillips posi-drive screws
- Soft White

Optional:

- Finishes B, C & F (see page 21)
- Fractional and O.D. sizes
- Flush frame (1100FF)

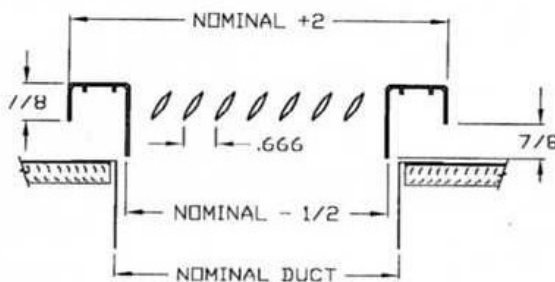
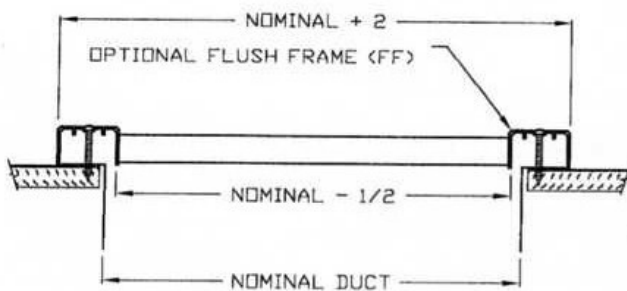

For Engineering information see page E15.



350 Series Perimeter Floor Diffuser

- Heavy gauge cold-rolled steel
- Louvers designed with rolled rib for maximum strength and rigidity with unique fan-shaped air pattern lending its applications for heating as well as air conditioning
- Opposed blade damper standard on 4" widths.
- Parallel blade damper on 6" widths and larger.
- All component parts, rivets, linkage, and handle, are enclosed in the valve to assure trouble-free operation
- Driftwood Tan

Optional:

- Finishes A, C & D (see page 21)

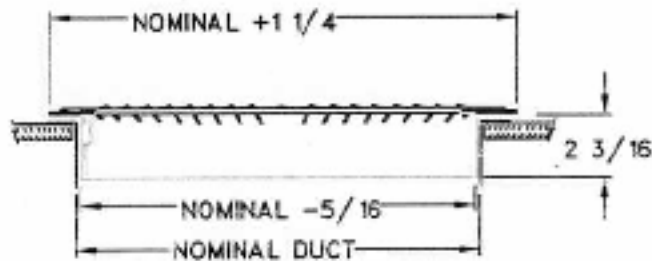
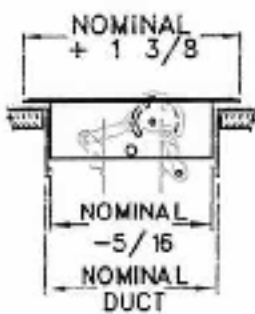

For Engineering information see page E10.



375 Series Deluxe Floor Diffuser

- All steel construction
- Individual vanes are resistance welded
- All component parts, rivets, linkage, and handle, are enclosed in the valve to assure trouble-free operation
- Locking screw provision concealed beneath the floor for tamper proof settings
- Opposed Blade Damper standard on 4" width diffusers
- Driftwood Tan

Optional:

- Finishes A, C (see page 21)

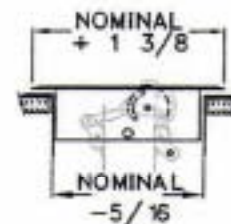
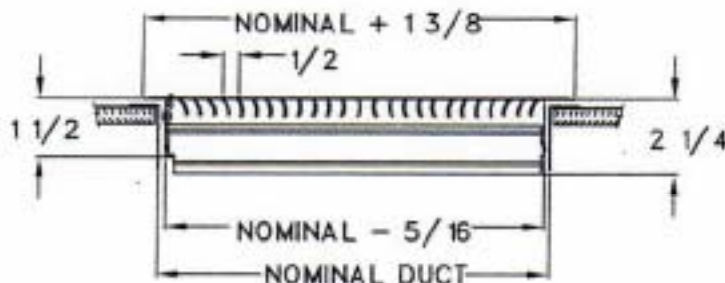

For Engineering information see page E11.

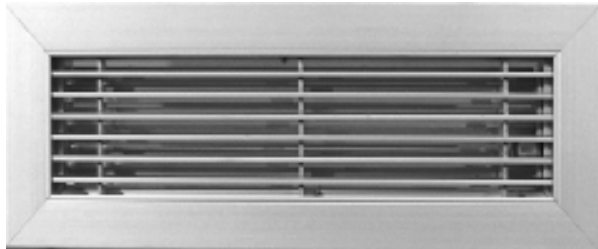

AFP Series Aluminum Floor Perimeter Diffuser

- All extruded aluminum construction
- Reinforced with pressure lock honeycomb construction to withstand heavy foot traffic
- 1/8" bars spaced on 1/2" centers
- Recessed screwdriver operated opposed blade damper to control air volume for positive balance
- Positive volume set screw
- Blades run parallel to longest dimension
- Satin anodized

Optional:

- 20 degree deflection
- Finishes A, B, C & H (see page 21)
- Gym Grade (**AFP GG**)
- Blades parallel to shortest dimension
- Grille only (**AFG**)

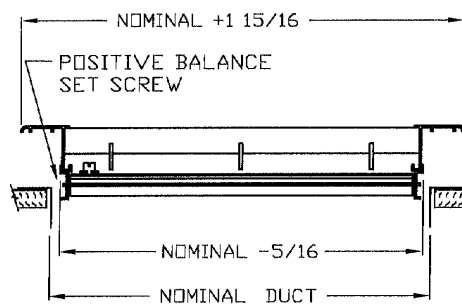
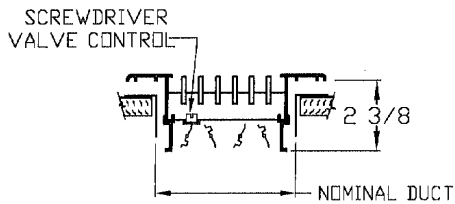

For Engineering information see page E12.



TS Series - Toe Space Grille

- Heavy duty cold roll steel as in the 350 series registers
- Ideal for return air in the toe space areas between kitchen cabinets, stair risers, built-in vanities and similar locations.
- Countersunk mounting holes for flush appearance with color matching Phillips posi-drive screws
- Driftwood Tan

Optional:

- TD Series: with damper, screw holes with color matching panhead screws
- Finishes A, C & D (see page 21)

NOTE: 4" TS design does not resemble photo. 4" design will sit flush with mounting surface.

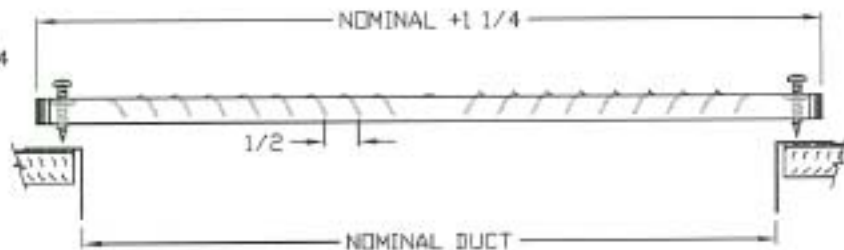
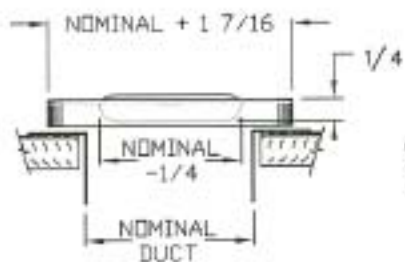

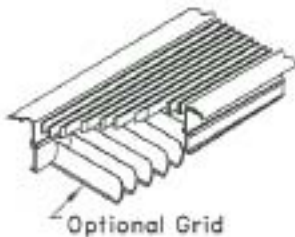

Linear Series

L 1/3 0°, L 1/3 20°, L 1/2 0°, L 1/2 20°

- All extruded aluminum construction
- LF floor application
- LS sill application
- LSW sidewall application with countersunk screw holes for neat appearance
- Reinforced with pressure lock honeycomb construction to withstand heavy foot traffic
- Available in 1/3" pencil-proof and 1/2" spacing
- Both spacings offer 0° deflection or 20° deflection
- Available in lengths of 144" in one piece
- Satin anodized finish standard
- Core blades run parallel to longest dimension

Optional:

- Recessed hand or screwdriver operated opposed blade damper (LF 1/2 20° O) to control air volume for positive balance of system.
- All extruded aluminum air deflection grid for individually adjustable curved blade deflection (LF 1/2 20° G)
- Mitered corners, Radius and special shapes (refer to commercial catalog)
- LF-GYM - Gym grade (welded blades, frame & extra blade supports)
- Finishes A, B, C & H (see page II)
- Access doors
- Butt joints for continuous look
- Core only, 1/2" or 1/3" spacing (see page 19)
- Frame Widths (example: LFX 1/2 20° O):

Standard	1 11/32"	}	see drawings below
Option X	1 1/4"		
Option Y	1"		
- Surface mounting holes available

For Engineering information see page E24

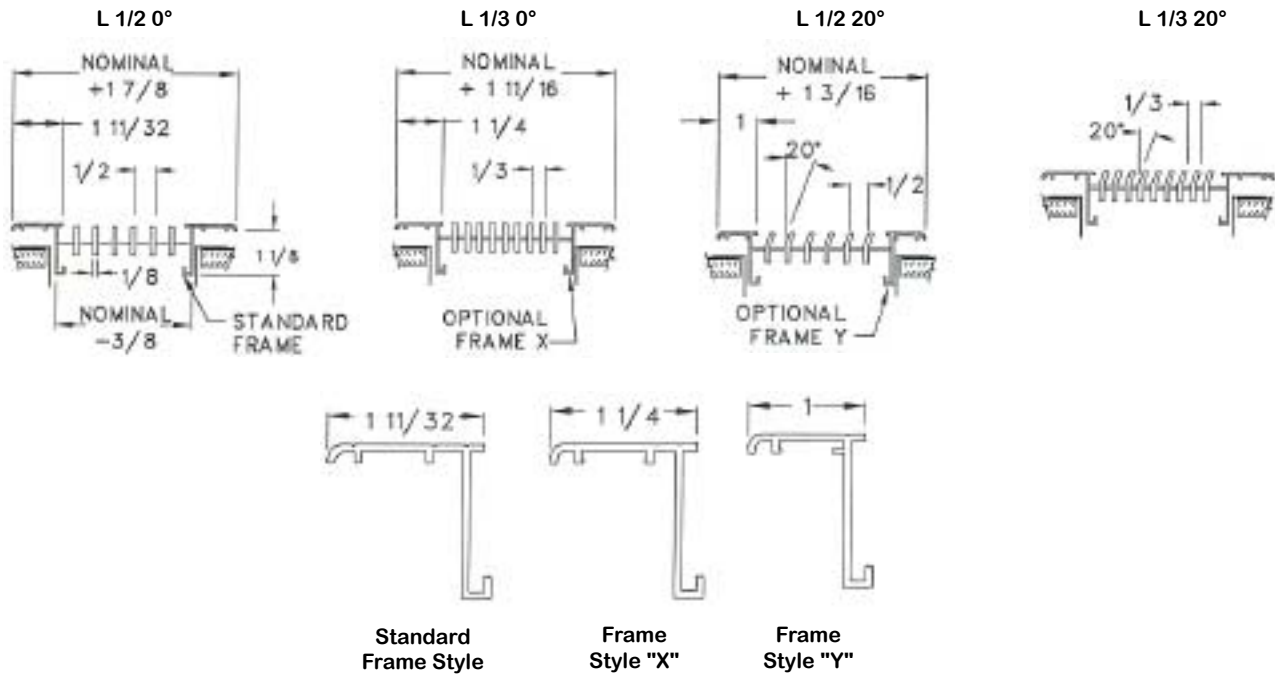

CORE ONLY - MOUNTING OPTIONS

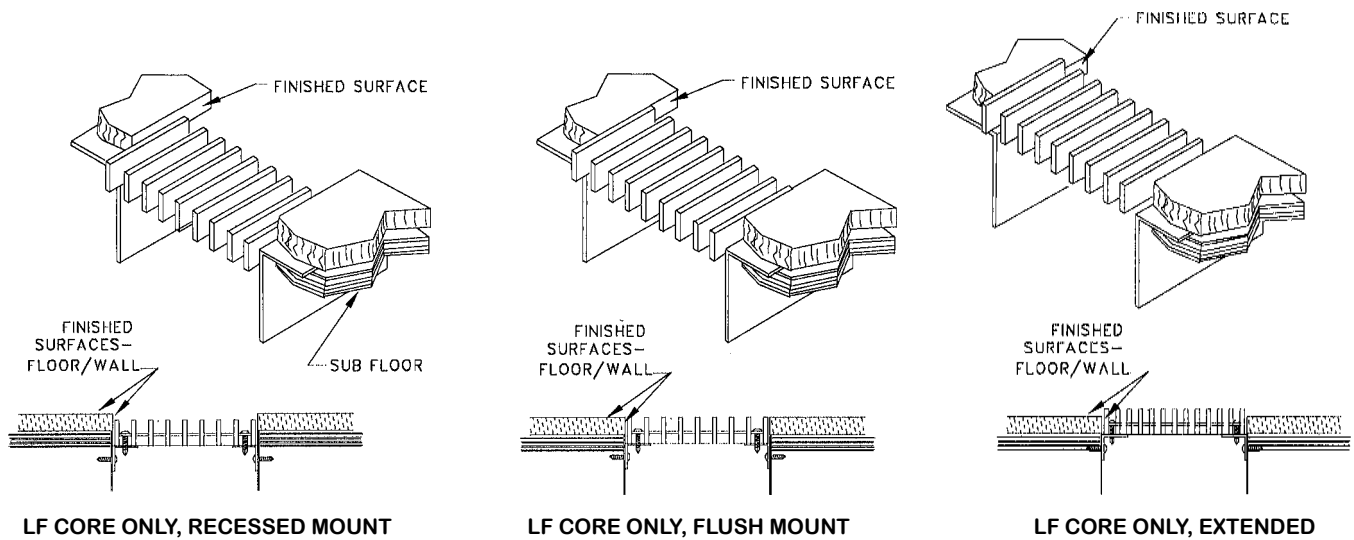

CORE ONLY - ORDERING & MOUNTING INFORMATION

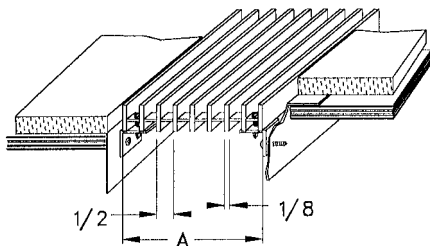

DIMENSION "A"
 Made in 1" increments @ 1/8" & 5/8"
 over the full inch.
 Example: 4 1/8", 6 5/8", etc.

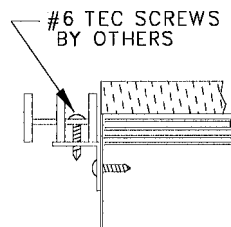

- Mounting location/Support strength brackets supplied by others,
- Recommended for floor applications: 16 ga. min.
- Use heavier gauge brackets more frequently in high traffic areas.

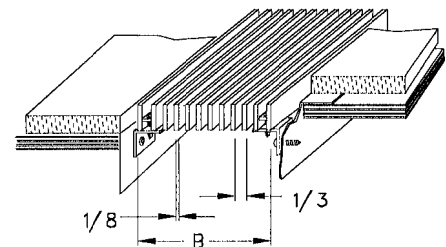

DIMENSION "B"
 Made in 1" increments @ 1/8", 7/16" &
 13/16" over the full inch.
 Example: 4 1/8", 6 13/16", 8 7/16", etc.

OBD & GRID OPTIONS

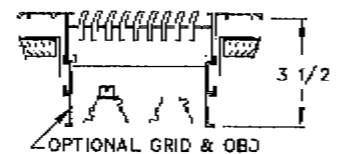
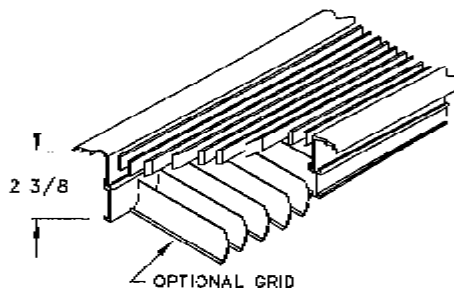
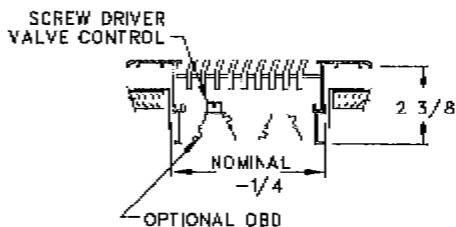



1550 Series Floor Register

- All steel honeycomb construction
- Flush core and frame provides smooth surface
- Free area equals more than 75% of nominal size
- Recessed screwdriver operated opposed blade damper to control air volume for positive balance of system
- Positive volume set screw
- Driftwood Tan

Optional:

- Mounting holes for sidewall and ceiling application
- Finishes A & C (see page 21)
- Reinforced (**1550R**) - welded core and extra support for heavy duty application

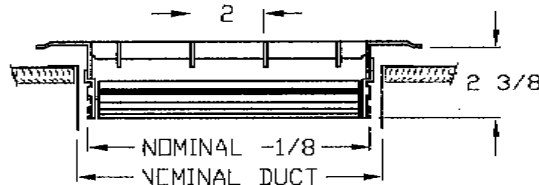
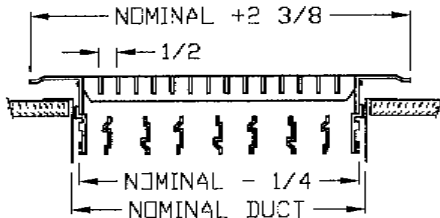

For Engineering information see page E19.

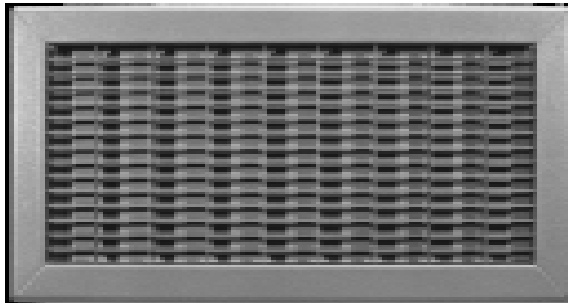

1600 Series Floor Grille

- All steel honeycomb construction
- Flush core and frame provides smooth surface
- Free area equals more than 75% of nominal size
- Driftwood Tan

Optional:

- Mounting holes for sidewall and ceiling application
- Reinforced (**1600R**) - welded core and extra supports for heavy duty application
- Finishes A, C, D & E (see page 21)

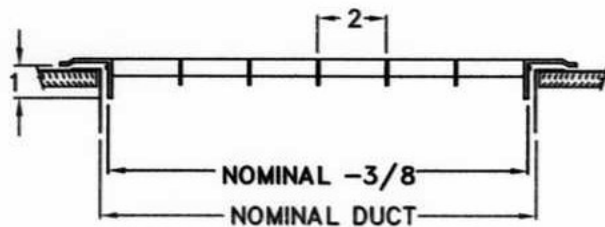
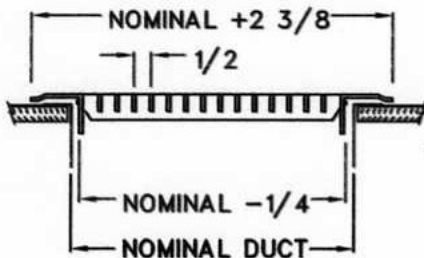

For Engineering information see page E21.

Our Designer Collection illustrates our ability to provide colors, metals and woods in a variety of styles, sizes and finishes. We are able to make special orders to meet your specific needs. We welcome the opportunity to provide unique, decorative and quality registers, grilles and diffuser to blend, accent or enhance your decorative style.



Colors pictured may vary slightly from the actual floor registers. Please check your dealer's display or use our color chip sample for actual register colors.

***PLATED METAL FINISHES AVAILABLE:**
 Polished brass • Antique brass • Polished chrome
 Copper* • Pewter • Satin Nickel • Black Nickel
 Oil Rubbed Bronze • 24 Carat Gold

* All plated items are special order.

** Driftwood Tan and Soft White are standard stock colors



AFP Series: Satin Anodized (standard)

Designer Series Standard Colors & Plating in our 350 Floor Diffuser

- Standard stock color and plated products in our 350 floor diffuser (see page 16 for product description)
- Opposed blade damper is standard on 4" widths.
- Standard perimeter sizes in stock:
 2 1/4" x 10, 12, 14"
 4" x 10, 12, 14"
 6" x 10, 12, 14"

Colors, Plating & Anodizing Special Order Products

- Many of our steel products may be special ordered in Designer Colors or Plated finishes. (Aluminum products cannot be plated)
- AFP Series comes in standard Satin Anodized finish. Also available in Bronze finish or Designer colors
- Please allow 2 weeks for Designer Colors special sizes
- Please allow 4-5 weeks for Plated Series special sizes
- Variations in plating can occur to change gloss and color slightly.

Wood Oak Series

- Standard 350 Series style in Natural finish Red Oak
- Self-rimmed
- Stationary vents (face only)
- Standard perimeter sizes in stock:
 - 2 1/4" x 10, 12, 14"
 - 4" x 10, 12, 14"
 - 6" x 10, 12, 14"

Optional:

- Steel parallel blade damper available, painted driftwood tan
- Non-standard sizes
- Over 250 different wood species available*
- Color match to major flooring brands*. Need color code and brand name
- Available unfinished*
- For Engineering and Complete Performance Data see page E23.



Self-rimmed 350 Series

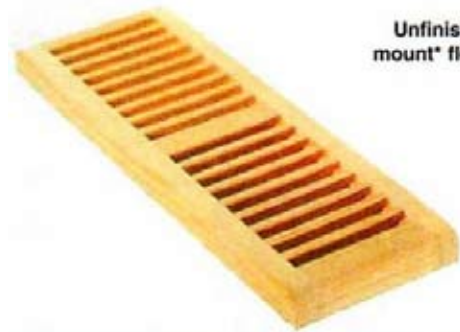

Unfinished flush mount* floor register

<p>Self-Rimmed Works well with any flooring, wall and ceiling applications. Order by duct size.</p>	<p>Flush Mount Ideal for hardwood flooring. *Flush mount available by special order only. Order by <u>exact</u> O.D. size.</p>																
<table border="1" data-bbox="646 1249 766 1327"> <thead> <tr> <th colspan="2">Duct Size</th> </tr> </thead> <tbody> <tr> <td>A</td> <td>+ 23/4</td> </tr> <tr> <td>B</td> <td>+ 23/4</td> </tr> </tbody> </table> <p>Rabbeted Ideal for 3/4" tongue & groove hardwood flooring. *Rabbeted rim available by special order only. Order by duct size.</p>	Duct Size		A	+ 23/4	B	+ 23/4	<table border="1" data-bbox="1302 1255 1422 1390"> <thead> <tr> <th colspan="2">Duct Size</th> </tr> </thead> <tbody> <tr> <td>A</td> <td>+ 23/4</td> </tr> <tr> <td>a</td> <td>+ 21/4</td> </tr> <tr> <td>B</td> <td>+ 23/4</td> </tr> <tr> <td>b</td> <td>+ 21/4</td> </tr> </tbody> </table> <p>Laminate To give a flush appearance on laminate flooring. *Laminate rim available by special order only. Order by duct size.</p>	Duct Size		A	+ 23/4	a	+ 21/4	B	+ 23/4	b	+ 21/4
Duct Size																	
A	+ 23/4																
B	+ 23/4																
Duct Size																	
A	+ 23/4																
a	+ 21/4																
B	+ 23/4																
b	+ 21/4																



3-WAY DIFFUSER*
(Flush mount shown)

*Available by special order

Wood Oak Series

Available by special order:

- Flush Mount
- Rabbeted Rim
- Self-Rim (non-standard sizes)
- Honeycomb Floor Grille (1600 style #20)
- Sidewall Return Air Grilles (1050 style #21)
- Various wood species
- Please allow 3-4 weeks for wood product special orders



20 - HONEYCOMB FLOOR GRILLE*
(WOOD OAK)



4-way Diffuser*
(Self-rimmed shown)



21 - SIDEWALL RETURN AIR GRILLE*

* Available by special order

Ornamental Series

- Solid Cast Iron
- Standard finishes Soft White or Driftwood Tan.
- Solid edge of grille approximately 3/16" thick

Optional:

- Available by special order in any of our designer colors (see page 1)
- **Solid Cast Brass** has lacquered finish to prevent tarnishing. Smooth finish and uniform surface for a clean look
- Dampers not available

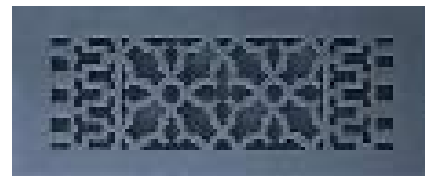

- Available in the following sizes:
2 1/4" x 10, 12, 14"
4" x 10, 12, 14"
6" x 10, 12, 14"

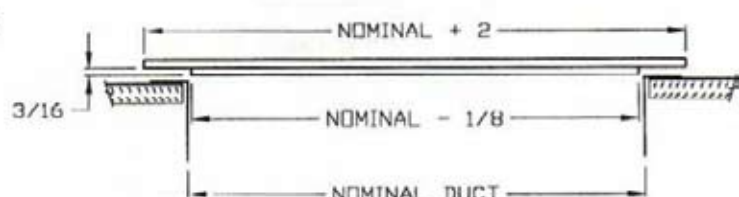
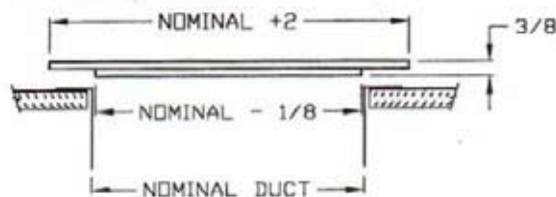

No Labor Collar

- For flex installation
- Square to round transition
- Mill finish

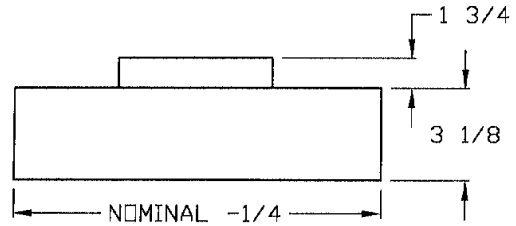

• For pricing refer to index on back page of current "Product Price List".

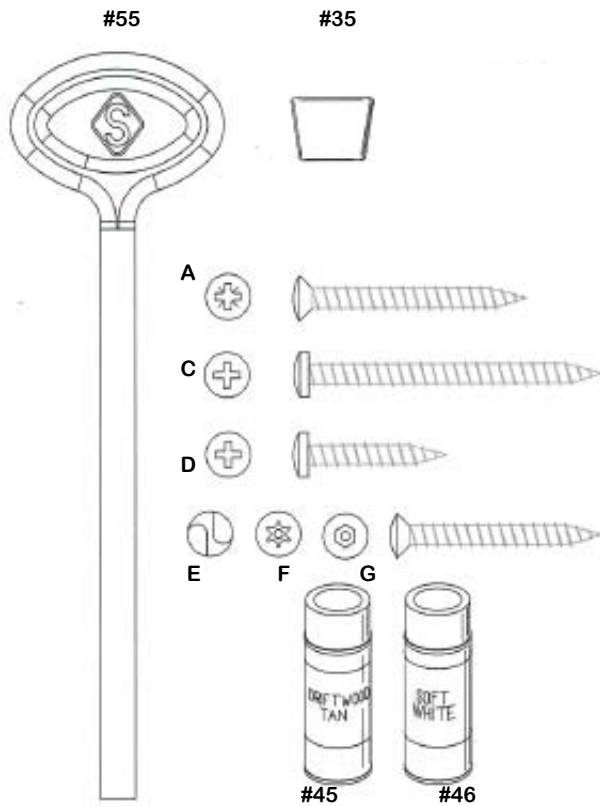

ITEM	DESCRIPTION
#35	Handle for registers & diffusers
#55	Bow-tie plastic handle
A	8 x 1 1/2" S.M.S. Phillips posi-drive Ovalhead
C	8 x 2" Phillips Panhead Screw (baseboard)
D	8 x 1" Phillips Panhead Screw (Toe space)
E	Tamper proof screw - 1 way S.M.S.
F	Tamper proof screw - T-15Torx H.P.
G	Tamper proof screw - 1/8 hex H.P.
H	1-way tamper proof screw removal tool
I	Torx T-15 H.P. Bit
J	1/8 hex H.P. Bit
#45	Driftwood Tan Spray Paint, 4.5 oz.
#46	Soft White Spray Paint, 4.5 oz.

Designer Collection Accessories:

- #22 Designer Series sample finish chips includes:
10 color, 7 plated & 1 wood chip
- #26 Designer Collection sample set,
Includes 4x10 floor registers in 10 colors, 3
plated & 1 Wood

Residential Products

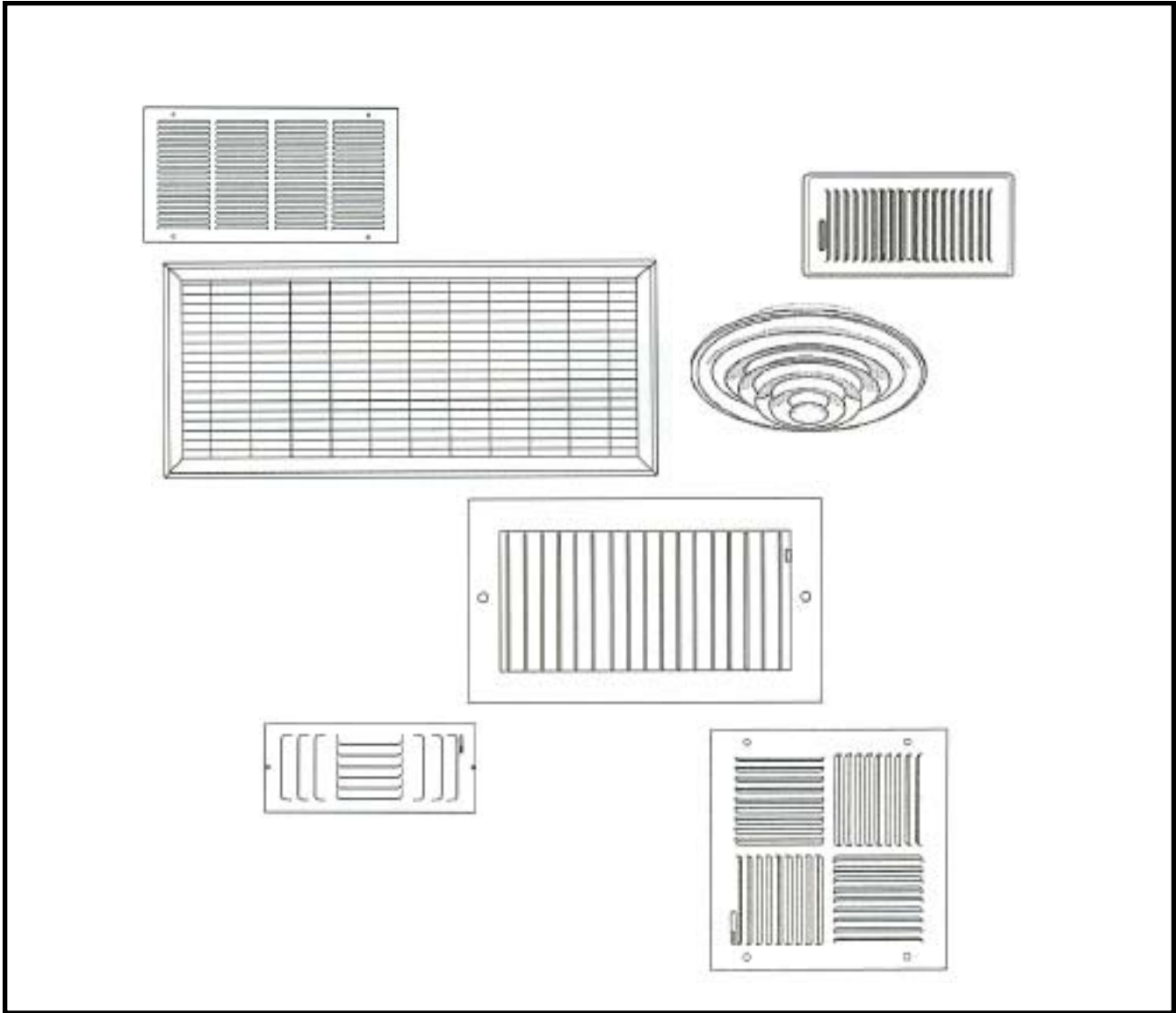

Registers, Grilles and Diffusers

REGISTER TYPE SELECTION: The register, since it is an inexpensive part of an air conditioning or heating system may get a minimum of consideration. Yet this is the device which brings the conditioned air into the presence of the occupants of the room and their judgement of the whole system may depend on how they consider the supply device works. The return grille has little effect on the conditions within a room as it is a device primarily for covering an opening and the design is important only from an appearance standpoint. The supply register can also be considered a device for covering an opening, in which case it would have thin vanes set to give a minimum resistance to air flow; this gives the maximum effective area for a given register's size. If the vanes of a register are set to fan the air it causes the supply air to mix quickly with the room air and the portion of the room where high air motion exists is considerably cut down. Setting the vanes to fan the air reduces the effective area. Considering only the effective area of a register can give a distorted view of its effect on the whole system an 18% increase in the effective area by changing the register from a fan type to a straighter flow type only increased the flow to the register by 3.3%. That is, the register loss is such a small percentage of the total branch line loss it is not a controlling factor in the flow to that branch.

REGISTER LOCATION: The measure of how well a given register location or design is performing can be determined by how much stratification (temperature difference between floor and ceiling) exists and how uniform the temperature is on any given level in the room.

THROW AND SPREAD: These terms can be misleading for someone who has not witnessed a smoke test on an air supply device. We tend to liken these terms to what happens when water or ink is spilled on a table. The distance it goes out and the amount it spreads to either side can be definitely measured. Air is a gas and cannot normally be seen, but when smoke is added its motion can be observed. Within limits when smoke is blown into a room from a supply, in a matter of seconds the room will be so filled with smoke one cannot find any spot to

get a breath of clean smokeless air. *THROW* is the distance from the supply to where the air speed has dropped sufficiently so that the air motion becomes unobjectionable. Air near the end of the throw moves in pulses, the velocity varying from 25, 50, to 100 FPM. At 100 FPM the air motion is beginning to be objectionable to most people. The throw is the distance to the point where the pulses do not go over 75 FPM. It should not, however, be assumed that if the length of the room happens to be more than the noted throw the air will reach the end of the room. When heating or cooling the problem is getting the air into the room without noticeable air motion and not getting the air dispersed into the room.

Air from a supply grille, register, or any opening maintains the same velocity for a reasonable distance (several inches) from the opening; and measuring the velocity is not too critical as to where the velocity measuring instrument is located. The same situation does not hold for the return grille. A return is basically what the aerodynamicist would call a *SINK*, or a point where air is being sucked in from all directions. Consequently the location of the velocity measuring instrument with respect to the distance away from the grille face can affect the velocity reading more than the actual air flow itself. From a point an inch or so in front of the grille to a point between the vanes the reading can vary over 100%. The effect of moving the instrument a given distance away from the grille face will also vary with the size and shape of the opening. The effective area will then vary with how far the velocity measuring device is located from the grille face. To eliminate this problem the effective area values for the returns in these tables have been selected so that the velocity measuring device was located between the grille vanes. This gives the true velocity reading and will depend only on the suction pressure behind the grille. The effective area values than appear low because of the high velocity reading. The effective area of a return depends primarily on the grille face area and the deflection angle on the vanes. With the vanes at right angle to the face the greatest flow area is obtained, but the grille is less effective in concealing the duct work.

Return Air Sizing Chart

Air brought back to the return air plenum of the furnace must equal the total volume of supply air delivered by the furnace. Careful sizing of return air grilles will assure an adequate air supply to the furnace and prevent air noise at the grille.

Knowing the total CFM delivered by a furnace, you can determine the total free area needed to service the system from the graph below.

Example: The furnace in a small home delivers (and requires) 1000 CFM. Trace the 1000 CFM line in the graph below to the points where it intersects the velocity lines. Now pick off the free areas required to handle 1000 CFM at these velocities from the vertical column on the left.

1000 CFM at 300 fpm requires 480 sq.in.
 1000 CFM at 400 fpm requires 360 sq.in.
 1000 CFM at 500 fpm requires 288 sq.in.
 1000 CFM at 600 fpm requires 240 sq.in.
 1000 CFM at 700 fpm requires 206 sq.in.
 1000 CFM at 800 fpm requires 180 sq.in.

When a practical velocity value has been established select a grille or grilles with free area equal to or exceeding the free area required for that velocity.

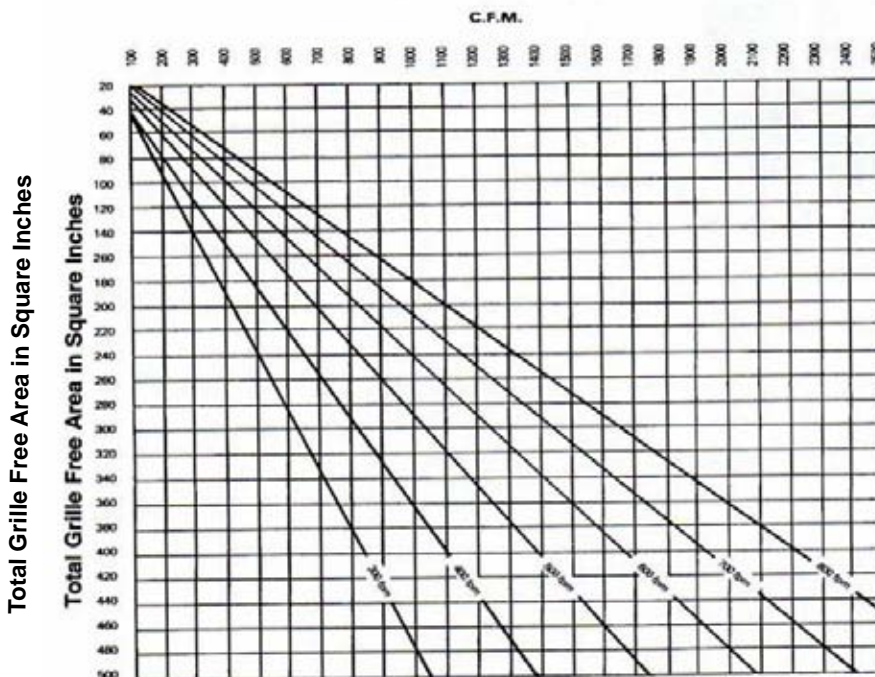

ALTERNATE SIZE CHART

**Grille Width
(Inches)**

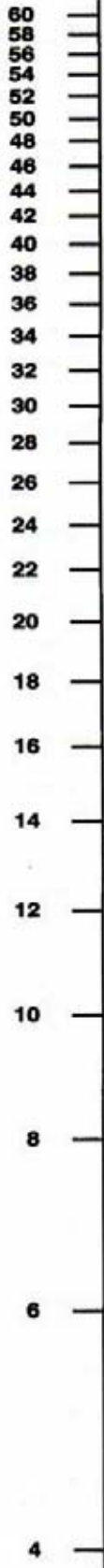

**Turning
Line**

TO DETERMINE ALTERNATE SIZES:

Place a straight edge across the width and height scales on dimensions as selected. Place a pointer at the crossing point on the turning line, and rotate the straight edge around this point until it crosses the width and height scale at a desired alternate size. Sizes determined from this chart are nominal duct dimensions.

SELECTION OF SIZES:

1. Throw should reach approximately 3/4 of distance from outlet to opposite wall.
2. Velocities of air in the air conditioned space are a major factor in the comfort of the occupants in that space. In general these velocities should not exceed 75 FPM in the occupied level in the room.
3. Due to difference of temperature between the entry air and the room air the entry air stream will drop below the level of introduction in the room. Extreme caution and good judgement are required in the selection and location of the supply of air conditioned air so that the air stream will not enter the occupied zone at the critical velocity and cause discomfort due to excessive drafts. If the entry air stream is overthrown and strikes the wall opposite of the grille location downdrafts will occur which will be objectionable to the occupants.

OUTLET SELECTION BY NOISE CRITERIA.

The following outlet selection takes into account the room absorption, ceiling height, number of outlets, etc., to match the tabulated outlet NC level with the space NC criteria. A direct comparison

**Grille Height
(Inches)**

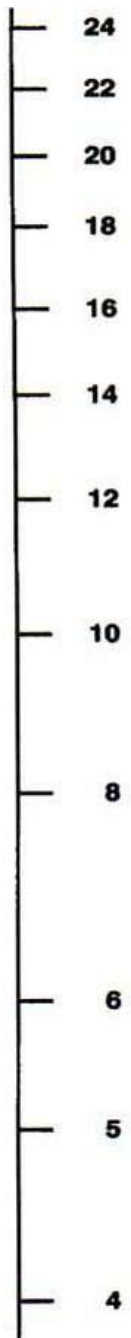

of the tabulated outlet NC level (assuming a 10 db room absorption and about a 5 ft. direct field from the single source) to the space NC criteria is used most frequently as a simple selection procedure. The actual outlet NC level obtained in a space depends on the sound power level from the outlet, the number of outlets, the distance from the outlet and the attenuation characteristics of the room. A complete treatment of this is found in the ASHRAE Handbook. However an approximate method follows.

RECOMMENDED DELIVERY VELOCITIES FOR VARIOUS APPLICATIONS.

The sound caused by an air outlet in operation varies in direct proportion to the velocity of the air passing through it. The air velocity can be controlled by selecting outlets of proper sizes. The following recommended outlet velocities are within safe sound limits for most applications:

Application	Recommended Face Velocities	NC-Criteria
Broadcasting studios	500 FPM	25
Residences	500 to 750 FPM	25-30
Apartments	500 to 750 FPM	25-30
Churches	500 to 750 FPM	25-30
Hotel bedrooms	500 to 750 FPM	25-30
Legitimate theatres	500 to 1000 FPM	20-35
Private offices, acoustically treated	500 to 1000 FPM	20-35
Motion picture theatres	1000 to 1250 FPM	35-40
Private offices, not treated	1000 to 1250 FPM	35-40
General offices	1250 to 1500 FPM	40-45
Stores, upper floors	1500 FPM	45
Stores, main floors	1500 FPM	45
Industrial buildings	1500 to 2000 FPM	>45

100 Series

Please refer to Footnote A & C below.

SIZE	Velocity	300	400	500	600	700	800	900	1000	1200
Eff.Area	Duct Pt	.007	.011	.017	.024	.034	.044	.055	.068	.100
6x6	CFM	54	68	86	105	123	137	161	173	185
.160 ft ²	Throw	3/6/4/4.4	4.5/5/5.5	5.5/6/6.5	6/7/8	7/8/9.5	8/9.5/11	9/11/13	9.5/12/14.5	10.5/13/15.5
	NC	<20	20	25	30	30	30	35	35	40
8x8	CFM	89	118	147	182	205	241	268	294	330
.275 ft ²	Throw	4.5/5/6	5.5/6/6.5	7/7.5/8.5	7.5/9/10.5	9.5/11/12.5	10/12/14	10.5/14/16	12/15/18	13/16/19
	NC	<20	20	25	30	30	30	35	35	40
10x10	CFM	134	179	221	263	316	352	407	441	485
.421 ft ²	Throw	5/5.5/6	6.5/7/7.5	7.5/8.5/9.5	8.5/10/11.5	10/12/14	12/14/16	13/16/19	13.5/17/20	15/19/23
	NC	<20	20	25	30	30	30	35	35	40
12x12	CFM	189	257	321	380	444	499	572	625	675
.591 ft ²	Throw	5.5/6/6.5	8/9/10	9.5/10.5/11.5	10/12/14	12/14/16	13.5/16/18	14.5/18/22	16/20/24	17/21/25
	NC	<20	25	30	30	30	30	35	35	40
14x14	CFM	257	353	431	515	604	701	792	861	925
.800 ft ²	Throw	6.5/7/7.5	8.5/9.5/10.5	11/12/13	12.5/14.5/17	14.5/17/20	16/19/22	17/21/25	19/24/29	21/26/31
	NC	<20	25	30	30	30	30	35	35	40
16x16	CFM	326	439	541	663	756	866	971	1102	1220
1.00 ft ²	Throw	7/8/9	9.5/10.5/11.5	11.5/13/14.5	13.5/16/18.5	16/19/22	18/21/24	18/23/28	22/27/32	24/30/36
	NC	<20	25	30	30	30	30	35	35	40
18x18	CFM	428	557	712	840	977	1118	1284	1423	1525
1.31 ft ²	Throw	8/9/10	10.5/11.5/12.5	13.5/15/17	15.5/18/21	18/21/24	20/24/28	22/27/32	24/30/36	26/33/40
	NC	20	25	30	30	35	35	35	40	40
20x20	CFM	504	685	856	1027	1176	1344	1512	1712	2000
1.55 ft ²	Throw	9/10/11	11.5/13/14.5	15.5/17/19	16/19/22	20/24/27	23/27/31	24/30/35	26/33/40	29/36/43
	NC	20	25	30	30	35	35	35	40	40
24x24	CFM	725	984	1208	1477	1723	1932	2174	2415	2800
2.21 ft ²	Throw	10.5/11.5/12.5	13.5/15/17	18/20/22	20/24/27	24/28/32	27/32/37	28/35/42	30/38/46	32/40/48
	NC	20	25	30	30	35	35	40	40	40

100D Series

Please refer to Footnote A & C below.

SIZE	Velocity	300	400	500	600	700	800	900	1000	1200
Eff.Area	Duct Pt	0.007	0.011	0.017	0.024	0.034	0.044	0.055	0.068	0.1
6x6	CFM	47	60	81	93	106	124	140	152	168
.152 ft ²	Throw	2.5/3/3.5	4/4.5/5	4.5/5/5.5	5/6/2007	6.5/7.5/8.5	7/8.5/10	7.5/8.5/10	8/10/2012	9.5/12/14.5
	NC	<20	20	25	30	30	30	35	35	40
8x8	CFM	81	102	129	162	181	207	238	258	285
.261 ft ²	Throw	4/4.5/5	4.5/5/5.5	6/6.5/7	7/8/2009	7.5/9/10.5	8.5/10/11.5	9/11.5/14	10.5/13/15.5	11.5/14.5/17
	NC	<20	20	25	30	30	30	35	35	40
10x10	CFM	116	158	193	230	280	312	350	386	425
.399 ft ²	Throw	4/4.5/5.5	5.5/6/6.5	7/7.5/8.5	7.5/9/10.5	9.5/11/12.5	10/12/2014	11/14/2017	12/15/2018	13.5/17/20
	NC	<20	20	25	30	30	30	35	35	40
12x12	CFM	166	223	285	327	394	437	492	553	620
.565 ft ²	Throw	5/5.5/6	7/7.5/8.5	8/9/2010	9.5/11/12.5	10/12/2014	12.5/14.5/17	13.5/17/20	14.5/18/22	17/21/25
	NC	<20	25	30	30	30	30	35	35	40
14x14	CFM	233	304	377	456	546	609	681	754	840
.765 ft ²	Throw	6/6.5/7	7.5/8.5/9.5	10/11/2012	10.5/12.5/14.5	13/15/17	14/17/19	15/19/22	17/21/25	19/24/29
	NC	<20	25	30	30	30	30	35	35	40
16x16	CFM	295	390	479	589	670	767	851	948	1060
.951 ft ²	Throw	6.5/7/7.5	8.5/9.5/10.5	10.5/11.5/12.5	12.5/14.5/17	14.5/17/20	16/19/22	16/21/25	19/24/29	22/28/34
	NC	<20	25	30	30	30	30	35	35	40
18x18	CFM	372	493	612	760	856	980	1116	1264	1450
1.25 ft ²	Throw	7/8/2009	9/10/2011	11.5/13/14.5	13.4/16/18	15.5/19/21	18/21/24	20/25/30	21/26/31	23/29/35
	NC	<20	25	30	30	35	35	35	35	40
20x20	CFM	446	589	744	883	1042	1216	1339	1488	1670
1.47 ft ²	Throw	8/9/2010	10/11/2012	13.5/15/17	14/17/19	17/21/24	20/24/28	21/26/31	23/29/34	24/30/36
	NC	<20	25	30	30	35	35	35	40	40
24x24	CFM	642	856	1058	1288	1530	1748	1904	2116	2400
2.11 ft ²	Throw	9.5/10.5/11.5	11.5/13/14.5	15.5/17/19	17/20/23	20/24/28	24/29/33	25/32/39	26/33/40	28/35/42
	NC	<20	25	30	30	35	35	35	40	40

FOOTNOTE A: SIZE: Nominal size or the duct opening. **EFFECTIVE AREA:** The space between the vanes actually utilized by the air.

VELOCITY: The actual velocity of the air through the vanes measured with a velometer or similar device.

DUCT Pt: The total pressure behind the register in the duct forcing that air through the register. **THROW:** The throws noted in the tables are the distance from the register to where the air stream velocity has dropped to not under 100/75/50 F.P.M.

FOOTNOTE C:
NOISE CRITERIA: NC "A" scale. (1) Below NC25 extremely quiet. (2) Below NC30 Quiet Office. (3) Below NC35 Conference Rooms; normal voice 10-30 ft. (4) Below NC40 Conference Rooms; 6-12 ft. normal voice. (5) NC45 Conference Rooms; 3-6 ft. normal voice.

200 Series

Please refer to Footnote A & C on page E4.

SIZE	Velocity	300	400	500	600	700	800	900	1000
Eff.Area	Duct Pt	0.006	0.01	0.015	0.021	0.029	0.038	0.048	0.065
6x6 .084 ft2	CFM	24	35	44	53	60	68	79	88
	Throw 201	4.5/5/5.5	5.5/6/6.5	7/8/2009	7.5/9/10.5	8.5/10/11.5	9.5/11/12.5	10.5/13/15.5	11/14/2017
	Throw 202	3.5/4/4.5	4.5/5/5.5	5.5/6/6.5	6/7/2008	7/8/2009	7.5/9/10.5	8/10/2012	9/11/2013
	Throw 203	2/2.5/3	2.5/3/3.5	3.5/4/4.5	4.5/5/6	5/6/2007	6/7/2008	6.5/8/9.5	7/9/2011
	Throw 204	2/2.5/3	2.5/3/3.5	3.5/4/4.5	4.5/5/6	5/6/2007	6/7/2008	6.5/8/9.5	7/9/2011
	NC	<20	<20	20	20	25	30	30	35
8x4 .074 ft2	CFM	24	30	38	42	54	58	66	76
	Throw 201	3.5/4/4.5	5.5/6/6.5	6.5/7/7.5	7/8/2009	7.5/9/10.5	9.5/11/12.5	9.5/12/14.5	11/14/2017
	Throw 202	2.5/3/3.5	3.5/4/4.5	4.5/5/5.5	5/6/2007	6/7/2008	7/8/2009	7/9/2011	8/10/2012
	Throw 203	2/2/2002	2.5/3/3.5	3.5/4/4.5	4.5/5/6	5/6/2007	6/7/2008	6.5/8/9.5	7/9/2011
	NC	<20	20	20	25	30	30	35	35
8x6 .112 ft2	CFM	33	44	56	67	82	91	100	116
	Throw 201	4.5/5/5.5	6.5/7/7.5	7/8/2009	8.5/10/11.5	10/12/2014	12/14/2016	12/15/2018	13.5/17/20
	Throw 202	2.5/3/3.5	4.5/5/5.5	5.5/6/6.5	6/7/2008	7.5/9/10.5	8.5/10/11.5	9/11/2013	9.5/12/14.5
	Throw 203	2.5/3/3.5	3.5/4/4.5	4.5/5/5.5	5/6/2007	6/7/2008	7/8/2009	7/9/2011	8/10/2012
	NC	<20	20	20	25	30	30	35	40
8x8 .151 ft2	CFM	42	62	76	90	105	118	133	155
	Throw 201	5.5/6/6.5	7/8/2009	8/9/2010	9.5/11/12.5	12/14/2016	13.5/16/18	14.4/18/22	16/20/24
	Throw 202	3.5/4/4.5	4.5/5/5.5	5.5/6/6.5	7/8/2009	8.5/10/11.5	9.5/11/12.5	9.5/12/14.5	11.2/14/17
	Throw 203	3.5/4/4.5	4.5/5/5.5	5.5/6/6.5	6/7/2008	7/8/2009	7.5/9/10.5	8/10/2012	9/11/2013
	Throw 204	2.5/3/3.5	3.5/4/4.5	4.5/5/5.5	5/6/2007	6/7/2008	7/8/2009	7/9/2011	8/10/2012
	NC	<20	20	25	25	30	35	35	40
10x4 .093 ft2	CFM	29	38	47	57	67	76	86	95
	Throw 201	4.5/5/5.5	5.5/6/6.5	7/8/2009	7.5/9/10.5	9.5/11/12.5	11/13/2015	12/15/2018	13/16/19
	Throw 202	2.5/3/3.5	4.5/5/5.5	5.5/6/6.5	6/7/2008	7/8/2009	8.5/10/11.5	9/11/2013	9.5/12/14.5
	Throw 203	2.5/3/3.5	3.5/4/4.5	4.5/5/5.5	5.5/6/6.5	6/7/2008	7/8/2009	6.5/8/9.5	7/9/2011
	NC	<20	20	25	25	30	35	35	40
10x6 .143 ft2	CFM	43	58	72	81	100	114	129	144
	Throw 201	4.5/5/5.5	6/7/2008	8/9/2010	9.5/11/12.5	11/13/2015	13/15/17	13.5/17/20	15/19/23
	Throw 202	3.5/4/4.5	4.5/5/5.5	6/7/2008	7/8/2009	7.5/9/10.5	8.5/10/11.5	9.5/12/14.5	10.5/13/15.5
	Throw 203	2.5/3/3.5	3.5/4/4.5	3.5/4/4.5	4.5/5/6	6/7/2008	6/7/2008	7/9/2011	7/9/2011
	NC	<20	20	25	25	30	35	40	40
10x10 .241 ft2	CFM	72	96	119	143	167	194	215	240
	Throw 201	6.5/7/7.5	8/9/2010	11/12/2013	13/15/17	14.5/17/10	17/20/23	18/23/28	20/25/30
	Throw 202	4.5/5/5.5	6.6/6/6.5	7/8/2009	10/12/2014	10/12/2014	11/13/2015	12/15/2018	13.5/17/20
	Throw 203	3.5/4/4.5	4.5/5/5.5	5.5/6/6.5	6/7/2008	7/8/2009	8.5/10/11.5	9/11/2013	10.5/13/15.5
	Throw 204	3.5/4/4.5	3.5/4/4.5	4.5/5/5.5	5/6/2007	6/7/2008	7.5/9/10.5	8/10/2012	9/11/2013
	NC	<20	20	25	25	30	35	40	40
12x4 .113 ft2	CFM	34	43	58	68	81	91	100	114
	Throw 201	4.5/5/5.5	6.5/7/7.5	8/9/2010	8.5/10/11.5	10/12/2014	12/14/2016	12/15/2018	14.5/18/22
	Throw 202	3.5/4/4.5	4.5/5/5.5	5.5/6/6.5	6/7/2008	7.5/9/10.5	8.5/10/11.5	9/11/2013	10.5/13/15.5
	Throw 203	2.5/3/3.5	3.5/4/4.5	4.5/5/5.5	4.5/5/6	5/6/2007	6/7/2008	6.5/8/9.5	7/9/2011
	NC	<20	20	25	25	30	35	40	45
12x6 .170 ft2	CFM	54	68	87	101	119	140	154	172
	Throw 201	5.5/6/6.5	7/8/2009	10/11/2012	10/12/2014	12/14/2016	14.5/17/20	14.5/18/22	17/21/25
	Throw 202	4.5/5/5.5	5.5/6/6.5	7/8/2009	7/8/2009	8.5/10/11.5	10/12/2014	10.5/13/15.5	12/15/2018
	Throw 203	3.5/4/4.5	4.5/5/5.5	6.5/7/7.5	6/7/2008	7/8/2009	7.5/9/10.5	8/10/2012	9.5/12/14.5
	NC	<20	20	25	30	30	35	40	45
12x12 .349 ft2	CFM	106	139	177	212	250	276	316	357
	Throw 201	8/9/2010	10/11/2012	13.5/15/17	15.5/18/21	18/21/24	21/24/28	22/27/32	24/30/36
	Throw 202	5.5/6/6.5	6.5/7/7.5	9/10/2011	10/12/2014	12/14/2016	13.5/16/18	14.5/18/22	16/20/24
	Throw 203	4.5/5/5.5	5.5/6/6.5	7/8/2009	8.5/10/11.5	9.5/11/12.5	11.5/13/15	11/14/2017	13/16/19
	Throw 204	3.5/4/4.5	4.5/5/5.5	5.5/6/6.5	7/8/2009	7.5/9/10.5	8.5/10/11.5	8/11/2013	10.5/13/15.5
	NC	<20	20	25	30	35	35	40	45
14x4 .133 ft2	CFM	38	54	67	81	96	106	116	134
	Throw 201	4.5/5/5.5	6.5/7/7.5	9/10/2011	9.5/11/12.5	11/13/2015	13/15/17	13/16/19	15/19/23
	Throw 202	3.5/4/4.5	4.5/5/5.5	6.5/7/7.5	7/8/2009	8.5/10/11.5	9.5/11/12.5	9.5/12/14.5	11/14/2017
	Throw 203	2.5/3/3.5	3.5/4/4.5	5.5/6/6.5	5/6/2007	6/7/2008	6.5/8/9	6.5/8/9.5	8/10/2012
	NC	<20	20	25	30	35	40	40	45
14x6 .200 ft2	CFM	62	82	101	119	139	163	182	200
	Throw 201	6.5/7/7.5	8/9/2010	9/10/2011	11/13/2015	13.5/16/18.5	15/18/21	16/20/24	18/22/26
	Throw 202	4.5/5/5.5	5.5/6/6.5	6.5/7/7.5	7.5/9/10.5	9.5/11/12.5	10/12/2014	11/14/2017	13/16/19
	Throw 203	3.5/4/4.5	4.5/5/5.5	5.5/6/6.5	6/7/2008	7/8/2009	7.5/9/10.5	8/10/2012	9.5/12/14.5
	NC	<20	20	25	30	35	40	45	45
14x8 .265 ft2	CFM	82	106	135	157	188	216	242	270
	Throw 201	7/8/2009	9/10/2011	11.5/13/14.5	13/15/17	14.5/17/20	17/20/23	18/23/28	20/25/30
	Throw 202	5.5/6/6.5	6.5/7/7.5	8/9/2010	9.5/11/12.5	10/12/2014	12/14/2016	13/16/19	13.5/17/20
	Throw 203	4.5/5/5.5	5.5/6/6.5	6.5/7/7.5	7/8/2009	7.5/9/10.5	8.5/10/11.5	10.5/13/15.5	11/14/2017
	NC	<20	20	25	30	35	40	45	45>
14x14 .481 ft2	CFM	144	191	242	288	338	387	447	494
	Throw 201	10/11/2012	12.5/14/15.5	16/18/20	18/21/24	21/25/29	23/27/31	26/32/38	29/36/43
	Throw 202	7/8/2009	8/9/2010	11/12/2013	12/14/2016	13.5/16/18	15.5/18/21	18/22/24	19/24/29
	Throw 203	5.5/6/6.5	6.5/7/7.6	8/9/2010	9.5/11/12.5	11/13/2015	12/14/2016	13.5/17/20	14.5/18/22
	Throw 204	4.5/5/5.5	5.5/6/6.5	7/8/2009	7.5/9/10.5	9.5/11/12.5	10/12/2014	11/14/2017	13/16/20
	NC	<20	25	30	30	35	40	45>	45>

SDD-1 One Way*

Please refer to Footnote A & C on page E7 for all SDD models.

SIZE	Velocity	300	400	500	600	700	800	900	1000	1200
Eff.Area	Duct Pt	.007	.011	.017	.024	.034	.044	.055	.068	.100
6x6	CFM	46	56	66	74	90	105	119	130	150
.13 ft ²	Throw	3.5/4/4.5	4.5/5/5.5	5.5/6/6.5	6/7/8	7/8/9	7/8/9	8/10/12	9/11/13	10.5/13/15.5
	NC	<20	<20	<20	<20	<20	20-25	20-25	25-30	25-30
8x8	CFM	60	75	90	04	119	135	150	165	195
.20 ft ²	Throw	4.5/5/5.5	5.5/6/6.5	6.5/7/7.5	7/8/9	8.5/10/11.5	9.5/11/12.5	9.5/12/14.5	10.5/13/15.5	13/16/19
	NC	<20	<20	<20	<20	<20	20-25	20-25	25-30	25-30
10x10	CFM	93	114	135	153	177	205	233	262	318
.29 ft ²	Throw	5.5/6/6.5	6.5/7/7.5	7/8/9	8.5/10/11.5	10/12/13.5	12/14/16	12/15/18	13.5/17/20	16/20/24
	NC	<20	<20	<20	<20	<20	20-25	20-25	25-30	25-30
12x12	CFM	136	172	208	258	300	338	376	423	517
.42 ft ²	Throw	6.5/7/7.5	7/8/9	9/10/11	10/12/14	13/15/17	14.5/17/20	15/19/23	18/22/26	20/25/30
	NC	<20	<20	<20	<20	20-25	20-25	25-30	30	35
14x14	CFM	198	253	308	356	414	457	500	555	665
.59 ft ²	Throw	9/10/11	10/11/12	11.5/13/14.5	13/15/17	15.5/18/21	18/21/24	19/24/30	22/27/32	26/32/38
	NC	<20	<20	<20	<20	20-25	20-25	25-30	30	35
16x16	CFM	255	307	397	460	530	588	650	720	850
.79 ft ²	Throw	11.5/13/14.5	12.5/14/15.5	14.5/16/18	15.5/18/21	18/21/24	20/24/28	22/27/32	25/31/37	30/38/46
	NC	<20	<20	20-25	25	25-30	30-35	35	35-40	>40

SDD-2 Two Way*

SIZE	Velocity	300	400	500	600	700	800	900	1000	1200
Eff.Area	Duct Pt	.007	.011	.017	.024	.034	.044	.055	.068	.100
6x6	CFM	47	56	65	76	89	105	121	131	149
.13 ft ²	Throw	2/2/2	2.5/3/3.5	3.5/4/4.5	4.5/5/5.5	5/6/7	5.5/6.5/7.5	5.5/7/8.5	6.5/8/9.5	8/10/12
	NC	<20	<20	<20	<20	<20	<20	<20	25	30
8x8	CFM	57	74	91	106	120	135	149	165	195
.20 ft ²	Throw	2.5/3/3.5	3.5/4/4.5	4.5/5/5.5	5/6/7	6/7/8	7/8/9	7/9/11	8.5/10.5/12.5	10.5/13/15.5
	NC	<20	<20	<20	<20	<20	<20	<20	25	30
10x10	CFM	98	116	134	153	177	205	233	262	318
.29 ft ²	Throw	3.5/4/4.5	4.5/5/5.5	5.5/6/6.5	6/7/8	7/8/9	7.5/9/10.5	8/10/12	10/12/14	12/15/18
	NC	<20	<20	<20	<20	<20	25	25	30	35
12x12	CFM	124	168	212	255	297	337	376	423	517
.42 ft ²	Throw	4.5/5/5.5	5.5/6/6.5	6.5/7/7.5	7/8/9	8.5/10/11.5	10/11.5/13	10.5/13/15.5	12/15/18	14.5/18/22
	NC	<20	<20	<20	<20	<20	25	25	30	35
14x14	CFM	204	253	302	356	406	458	510	560	660
.59 ft ²	Throw	4.5/5/5.5	6.5/7/7.5	8/9/10	9.5/11/12.5	11/13/15	12/14.5/16.5	13/16/19	14.5/18/22	16/20/24
	NC	<20	<20	<20	<20	<20	25	25	30	35
16x16	CFM	255	307	397	460	530	588	650	720	850
.79 ft ²	Throw	11.5/13/14.5	12.5/14/15.5	14.5/16/18	15.5/18/21	18/21/24	20/24/28	22/27/32	25/31/37	30/38/46
	NC	<20	<20	20-25	25	25-30	30-35	35	35-40	>40

SDD-2C Two Corner*

SIZE	Velocity	300	400	500	600	700	800	900	1000	1200
Eff.Area	Duct Pt	.007	.011	.017	.024	.034	.044	.055	.068	.100
6x6	CFM	46	56	66	74	90	105	119	130	150
.13 ft ²	Throw	2/2/2	2.5/3/3.5	3.5/4/4.5	4.5/5/5.5	5/6/7	5.5/6.5/7.5	5.5/7/8.5	6.5/8/9.5	8/10/12
	NC	<20	<20	<20	<20	<20	<20	<20	25	30
8x8	CFM	60	75	90	104	119	135	150	165	195
.20 ft ²	Throw	2.5/3/3.5	3.5/4/4.5	4.5/5/5.5	5/6/7	6/7/8	7/8/9	7/9/11	8.5/10.5/12.5	10.5/13/15.5
	NC	<20	<20	<20	<20	<20	<20	<20	25	30
10x10	CFM	93	114	135	153	177	205	233	262	318
.29 ft ²	Throw	3.5/4/4.5	4.5/5/5.5	5.5/6/6.5	6/7/8	7/8/9	7.5/9/10.5	8/10/12	10/12/14	12/15/18
	NC	<20	<20	<20	<20	<20	25	25	30	35
12x12	CFM	136	172	208	258	300	338	376	423	517
.42 ft ²	Throw	4.5/5/5.5	5.5/6/6.5	6.5/7/7.5	7/8/9	8.5/10/11.5	10/11.5/13	10.5/13/15.5	12/15/18	14.5/18/22
	NC	<20	<20	<20	<20	<20	<20	25	30	35
14x14	CFM	198	253	308	356	414	457	500	555	665
.59 ft ²	Throw	4.5/5/5.5	6.5/7/7.5	8/9/10	9.5/11/12.5	11/13/15	12/14.5/16.5	13/16/19	14.5/18/22	16/20/24
	NC	<20	<20	<20	<20	<20	25	25	30	35
16x16	CFM	255	307	397	460	530	588	650	720	850
.79 ft ²	Throw	11.5/13/14.5	12.5/14/15.5	14.5/16/18	15.5/18/21	18/21/24	20/24/28	22/27/32	25/31/37	30/38/46
	NC	<20	<20	20-25	25	25-30	30-35	35	35-40	>40

SDD-3 Three Way*

Please refer to Footnote A & C below for all SDD models

SIZE	Velocity	300	400	500	600	700	800	900	1000	1200
Eff.Area	Duct Pt	.007	.011	.017	.024	.034	.044	.055	.068	.100
6x6	CFM	56	46	66	74	91	105	119	130	150
.13 ft²	Throw A	2.5/3/3.5	3/3.5/4	3.5/4/4.5	4.5/5/6	4.5/5.5/6.5	5/6/7	5.5/7/8.5	6.5/8/9.5	8/10/12
	Throw B	2.5/3/3.5	2.5/3/3.5	3/3.5/4	3/3.5/4	3.5/4/4.5	4.5/5/6	5/6/7	5.5/6/7.5	6/7/8
	NC	<20	<20	<20	<20	<20	<20	<20	25	30
8x8	CFM	63	76	89	104	119	136	152	166	195
	Throw A	2.5/3/3.5	3.5/4/4.5	4.5/5/5.5	5/6/7	6/7/8	6.5/7.5/8.5	6.5/8/9.5	9/9/11	9/11/13
	Throw B	2/5.3/3.5	3/3.5/4	3/3.5/4	4/4.5/5	5/6/7.5	5/6.5/8	6/7/8	6.5/7/8.5	7/8/10
10x10	NC	<20	<20	<20	<20	<20	<20	<20	25	30
	CFM	92	114	136	157	173	203	233	262	318
	Throw A	2.5/3/3.5	4.5/5/5.5	6.5/7/7.5	7/8/9	8.5/10/11.5	9.5/11/12.5	9.5/12/14.5	10.5/13/15.5	13/16/19
.29 ft²	Throw B	2.5/3/3.5	3.5/4/5	4/5/6	5/6/7	6/7.5/8	6.5/8/9	7/9/11	8/10/12	10/12/14
	NC	<20	<20	<20	<20	<20	<20	<20	25	30
	CFM	136	172	208	258	297	339	380	425	517
.42 ft²	Throw A	5.5/6/6.5	6.5/7/7.5	7.5/8.5/9.5	8.5/10/11.5	9.5/11/12.5	11.5/13.5/15.5	12/15/18	13/17/20	16/20/24
	Throw B	4/5/6	4.5/6/7	5/6.5/8	6/8/9.5	7/9/11	8/10.5/12	9/11/13	10.5/12/14	11/13/15
	NC	<20	<20	<20	<20	<20	25	25	30	35
14x14	CFM	204	253	302	356	406	453	500	555	665
	Throw A	5.5/6/6.5	7/8/9	9/10/11	10/11.5/13	11/13/15	12/14/16	12.5/15.5/19	14.4/18/22	18/22/26
	Throw B	4/5/6	5/6.5/7	6/7/8.5	7/8.5/9.5	8/9.5/11	8/11.5/13	10/12/14	11/13.5/15	13/15/19
16x16	NC	<20	<20	<20	<20	<20	25	25	30	35
	CFM	255	307	397	460	530	588	650	720	850
	Throw A	12/13/14.5	12.5/14/15.5	14.5/16/18	15.5/18/21	18/21/24	20/24/28	22/27/32	25/31/37	30/38/46
.79 ft²	Throw B	8/9.5/11	9/10/12	10/12/15	12/14/16	13/15/18	15/18/20	18/20/23	20/22/25	24/27/31
	NC	<20	<20	20-25	25	25-30	30-35	35	35-40	>40

SDD-4 Four Way*

SIZE	Velocity	300	400	500	600	700	800	900	1000	1200
Eff.Area	Duct Pt	.007	.011	.017	.024	.034	.044	.055	.068	.100
6x6	CFM	44	54	64	76	91	106	121	131	149
.13 ft²	Throw	1/1/1	2/2/2	2/3/3.5	3.5/4/4.5	4.5/5/6	4.5/5.5/6.5	5/6/7	5.5/7/8.5	7/9/11
	NC	<20	<20	<20	<20	<20	25	25	25	30
8x8	CFM	57	74	91	106	119	134	149	165	195
	Throw	2/2/2	2.5/3/3.5	3.5/4/4.5	4.5/5/5.5	5/6/7	6/7/8	6.5/8/9.5	8/10/12	9.5/12/14.5
10x10	NC	<20	<20	<20	<20	<20	25	25	25	30
	CFM	94	114	134	153	173	205	237	264	316
.29 ft²	Throw	2.5/3/3.5	3.5/4/4.5	4.5/5/5.5	5/6/7	6/7/8	7/8/9	7/9/11	9.5/12/14.5	10.5/13/15.5
	NC	<20	<20	<20	<20	<20	25	25	25	30
12x12	CFM	128	168	208	252	287	336	384	427	513
	Throw	3.5/4/4.5	4.5/5/5.5	5.5/6/6.5	6/7/8	7/8/9	7.5/9/10.5	8/10/12	9/11/13	10.5/13/15.5
14x14	NC	<20	<20	<20	<20	<20	25	25	25	30
	CFM	198	253	308	364	406	453	500	555	665
.59 ft²	Throw	5.5/6/6.5	6.5/7/7.5	8/9/10	9.5/11/12.5	11/13/15	12.5/14.5/17	13/16/19	13.5/17/20	12/15/18
	NC	<20	<20	<20	<20	25	25	25	30	35
16x16	CFM	255	307	397	460	530	588	650	720	850
	Throw	11.5/13/14.5	12.5/14/15.5	14.4/16/17.5	15.5/18/21	18/21/24	20/24/28	22/27/32	25/31/37	30/38/46
.79 ft²	NC	<20	<20	20-25	25	25-30	30-35	35	35-40	>40

***Core Pattern Drawings:**

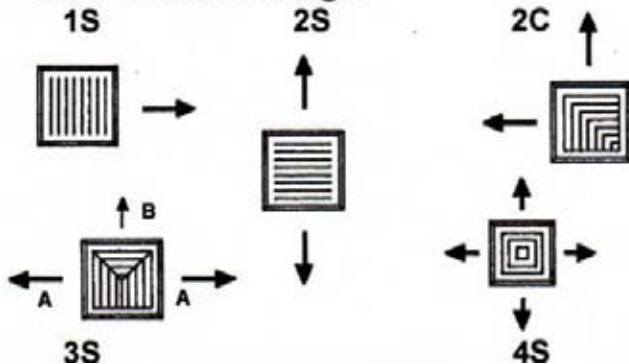

FOOTNOTE A:

- SIZE:** Nominal size or the duct opening.
- EFFECTIVE AREA:** The space between the vanes actually utilized by the air.
- VELOCITY:** The actual velocity of the air through the vanes measured with a velometer or similar device.
- DUCT Pt:** The total pressure behind the register in the duct forcing that air through the register.
- THROW:** The throws noted in the tables are the distance from the register to where the air stream velocity has dropped to not under 100/75/50 F.P.M.

FOOTNOTE C:

- NOISE CRITERIA:** NC "A" scale. (1) Below NC25 extremely quiet. (2) Below NC30 Quiet Office. (3) Below NC35 Conference Rooms; normal voice 10-30 ft. (4) Below NC40 Conference Rooms; 6-12 ft. normal voice. (5) NC45 Conference Rooms; 3-6 ft. normal voice.

90 Series

Please refer to Footnote A & C below.

SIZE Eff.Area	Velocity Duct Pt	300 .007	400 .011	500 .017	600 .024	700 .034	800 .044	900 .055	1000 .068
6" .141 ft ²	CFM	45	56	67	82	98	107	124	138
	Throw	2/2/2	2.5/2.5/3	2.5/3/3.5	3/3.5/4	3.5/4/4.5	4/4.5/5	4/5/6	5/6/7
	NC	<20	20	25	25	30	30	30	35
8" .222 ft ²	CFM	71	92	118	134	165	184	204	232
	Throw	2/2/2	2.5/3/3.5	3/3.5/4	4.5/5/6	4.5/5.5/6.5	5/6/7	5.5/7/8.5	6/7.5/9
	NC	<20	20	25	25	30	30	30	35
10" .348 ft ²	CFM	107	143	179	214	245	281	316	352
	Throw	2.5/2.5/3	3/3.5/4	4/4.5/5	4.5/5/6	5/6/7	6/7/8	6.5/8/9.5	7/8.5/10
	NC	<20	20	25	30	30	30	35	35
12" .508 ft ²	CFM	153	204	250	306	357	408	459	510
	Throw	2.5/3/3.5	3.5/4/4.5	4.5/5/5.5	5/6/7	6.5/7.5/8.5	7.5/8.5/9.5	7/9/11	9/11/13
	NC	<20	20	25	30	30	35	35	35
14" .628 ft ²	CFM	194	255	321	383	449	510	576	638
	Throw	3/3.5/4	4/4.5/5	5/5.5/6	5.5/6.5/7.5	7/8/9	7.5/9/10.5	8/10/12	9/11/13
	NC	<20	20	25	30	30	35	35	40

150 Series

Please refer to Footnote A & C below.

SIZE Eff.Area	Velocity Duct Pt	400 .011	500 .017	600 .024	700 .034	800 .044	900 .055	1000 .068	1200 .100
6x6 .100 ft ²	CFM	45	65	85	95	100	105	110	125
	Throw	2.5/2.5/3	2.5/3/3.5	2.5/3/3.5	3/3.5/4	3.5/4/4.5	3.5/4.5/5.5	4/5/6	4.5/5.5/6.5
	NC	25	25	25	30	30	35	35	40
8x8 .201 ft ²	CFM	80	100	120	140	160	180	200	240
	Throw	2/2/2.5	2.5/3/3.5	2.5/3/3.5	3/3.5/4	3.5/4/5	4/5/6	4/5.5/6	5/6.5/7.5
	NC	25	25	25	30	30	35	35	40
10x10 .299 ft ²	CFM	124	155	186	205	248	280	310	374
	Throw	3.5/3/3	3/3.5/4	3.5/4.5/5	4.5/5/6	5/6/6.5	5/6/7	6/7/8.5	7/8.5/10.5
	NC	25	25	25	30	30	35	40	40
12x12 .465 ft ²	CFM	180	225	270	330	360	405	450	540
	Throw	3/3.5/4	4/4.5/5	4.5/5/6	5/6/7	6/7/8	6/7.5/9	7/8.5/10.5	8.5/10.5/12.5
	NC	25	25	30	30	35	35	40	40
14x14 .645 ft ²	CFM	280	340	420	490	560	630	700	840
	Throw	4/4.5/5	4.5/5/5.5	5.5/6.5/7.5	6.5/7.5/8.5	7.5/8.5/10	7.5/9.5/11.5	8.5/11/13	10.5/13/15.5
	NC	25	25	30	30	35	35	40	40
16x16 .925 ft ²	CFM	507	616	761	887	1015	1120	1270	1471
	Throw	14/15.5/17	17/19/21	20/23/27	21/25/29	25/29/33	24/30/36	25/31/37	27/34/41
	NC	25	25	30	30	35	35	40	40
18x18 1.25 ft ²	CFM	624	796	936	1127	1247	1390	1610	1873
	Throw	15.5/17/19	18/20/22	20/23/27	22/26/30	26/30/35	25/31/37	26/33/39	28/35/42
	NC	25	25	30	35	35	40	40	40
20x20 1.55 ft ²	CFM	780	992	1158	1389	1542	1750	1987	2316
	Throw	15.5/17/19	20/22/24	20/24/28	23/27/31	25/30/34	25/31/37	26/32/38	29/36/43
	NC	25	25	30	35	35	40	40	40

452 Series

Please refer to Footnote A & C below.

SIZE Eff.Area	Velocity Duct Pt.	400 .011	500 .017	600 .024	700 .034	800 .044	900 .055	1000 .068	1200 .100	1400 .122
16x16 .585 ft ²	CFM	191	237	287	337	383	434	482	574	666
	Throw	7/8/9	9/10/11	10/12/14	14/16/19	14/16/19	14/18/22	16/20/23	20/24/29	23/28/33
18x18 .711 ft ²	CFM	245	310	379	436	490	553	612	734	933
	Throw	8/9/10	11/12/13	12/14/15	14/16/19	15/18/21	16/20/23	18/23/27	22/27/32	25/32/38
20x20 .860 ft ²	CFM	290	375	444	520	597	667	742	895	1045
	Throw	10/11/12	13/14/15	14/16/19	16/19/22	18/22/25	19/23/28	22.27.32	26.32.39	30.37.44
24x24 1.25 ft ²	CFM	428	536	643	750	857	969	1071	1285	1492
	Throw	11/12/13	13/14/16	15/18/21	18/21/24	20/23/27	20/25/31	23/29/34	27/34/41	31/38/45

FOOTNOTE A:
SIZE: Nominal size or the duct opening.

EFFECTIVE AREA: The space between the vanes actually utilized by the air.

VELOCITY: The actual velocity of the air through the vanes measured with a velometer or similar device.

DUCT Pt: The total pressure behind the register in the duct forcing that air through the register.

THROW: The throws noted in the tables are the distance from the register to where the air stream velocity has dropped to not under 100/75/50 F.P.M.

FOOTNOTE C:
NOISE CRITERIA: NC "A" scale. (1) Below NC25 extremely quiet. (2) Below NC30 Quiet Office. (3) Below NC35 Conference Rooms; normal voice 10-30 ft. (4) Below NC40 Conference Rooms; 6-12 ft. normal voice. (5) NC45 conference Rooms; 3-6 ft. normal voice.C

400 Series

Please refer to Footnote A & C on page E8.

SIZE	Free Area	Velocity	500	700	800	900	1000	1200	1500	2000
Inches	Sq. Inch	Duct Pt	.017	.034	.044	.055	.068	.100	.135	.220
6x6	74	CFM	70	100	120	130	155	184	230	310
		Throw	3.5/4/4.5	4/4.5/5	4.5/5/6	5/5.5/6/5	5.5/6.5/7.5	6/7.5/9	7.5/9.5/11.5	10/12.5/15
8x8	111	CFM	85	130	145	168	184	226	285	385
		Throw	3.5/4/4.5	4.5/5/5.5	4.5/5.5/6	5/6/7	6/7/8.5	6.5/8/9.5	8/10/12	11/13.5/16
10x10	148	CFM	135	210	250	275	305	342	452	610
		Throw	5/5.5/6	6/6.5/7.5	6/7.5/8.5	7/8/9.5	8/9.5/11	8.5/10.5/11.5	10.5/13.5/16	14/17/21
12x12	185	CFM	210	335	385	425	460	590	715	940
		Throw	5.5/6/7	8/9/10	9.5/11/12.5	10/12/13.5	11.5/13.5/15.5	12/14.5/16	14/18/21	19/24/29
14x14	222	CFM	340	480	555	615	695	840	1040	1375
		Throw	7/7.5/8.5	9.5/10.5/11.5	10/12/13.5	11.5/13.5/15.5	13/15/17	14/18/21	19/24/29	22/27/32
16x16	229	CFM	465	650	758	840	990	1200	1420	1910
		Throw	8/8.5/9.5	11/12/13	11.5/13.5/15.5	13/15/17	15/18/20	17/22/26	21/26/31	26/33/40
18x18	296	CFM	625	875	1010	1125	1275	1525	1850	2510
		Throw	10/11/12	13.5/15/17	14/16/19	16/19/22	18/21/25	21/26/31	30/38/45	34/43/51
20x20	333	CFM	810	1125	1305	1409	1650	2085	2475	3250
		Throw	10.5/11.5/13	14.5/16/18	15.5/18/21	18/21/25	20/23/27	23/28/34	27/34/41	36/45/54
24x24	407	CFM	1200	1690	1905	2265	3000	3585	4710	5325
		Throw	12.5/14/15.5	17/19/21	18/21/25	21/25/28	29/34/39	33/41/50	45/56/67	46/58/69
26x26	418	CFM	1440	2024	2293	2671	3330	3985	5153	6154
		Throw	14.8	20.7	22.7	26.1	35.7	43.9	59.1	61.2
28x28	440	CFM	1920	2691	3069	3483	3990	4785	6038	7812
		Throw	16.3	22.1	24.7	28.4	39	46.5	64.1	67.5
30x30	451	CFM	2160	3024	3456	3888	4320	5184	6480	8640
		Throw	17.4	23.9	26.6	30.2	41.4	49.6	68.9	71.7
32x32	470	CFM	2246	3145	3594	4044	4493	5391	6739	8986
		Throw	18.1	25.3	27.7	31.8	43.7	51.1	72.3	74.9

425 Series

Please refer to Footnote A & C on page

SIZE	Velocity	300	400	500	600	700	800	900	1000	1200
Eff.Area	Duct Pt	.007	.011	.017	.024	.034	.044	.055	.068	.100
14x14	CFM	257	353	431	515	604	701	792	861	920
	Throw	6.5/7/7.5	8.5/9.5/10.5	11/12/13	12.5/14.5/17	14.5/17/20	16/19/22	17/21/25	19/24/30	21/26/31
16x16	CFM	326	439	541	663	756	866	971	1102	1220
	Throw	7/8/9	9.5/10.5/11.5	11.5/13/14.5	13.5/16/18	16/19/22	18/21/24	18/23/28	22/27/32	24/30/36
18x18	CFM	428	557	712	840	977	1118	1284	1423	1525
	Throw	8/9/10	10.5/11.5/12.5	13.5/15/17	15.5/18/21	18/21/24	20/24/28	22/27/32	24/30/36	26/33/40
20x20	CFM	504	685	856	1027	1176	1344	1512	1712	2000
	Throw	9/10/11	12/13/14.5	15.5/17/19	16/19/22	20/24/27	23/27/31	24/30/35	26/33/40	29/36/43
24x24	CFM	725	984	1208	1477	1723	1932	2174	2415	2800
	Throw	10.5/11.5/12.5	13.5/15/17	18/20/22	20/23.5/27	24/28/32	27/32/37	28/35/42	30/38/46	32/40//48
	NC	20	25	30	30	35	35	35	40	40
	NC	20	25	30	30	35	35	35	40	40

450 Series

Please refer to Footnote A & C on page E8.

SIZE	Velocity	400	500	600	700	800	900	1000	1200	1400
Eff.Area	Duct Pt.	.011	.017	.024	.034	.044	.055	.068	.100	.122
16x16	CFM	225	279	338	396	450	510	567	675	783
	Throw	8/9/10	10/11/12	11/13/15	13/15/17	15.5/18/21	16/20/24	18/22/27	22/27/32	25/31/37
18x18	CFM	288	365	446	513	576	650	720	864	1098
	Throw	9/10/11	11.5/13/14.5	13/15/17	15.5/18/21	17/20/23	18/22/26	20/25/30	24/30/36	28/35/42
20x20	CFM	342	441	522	612	702	785	873	1053	1229
	Throw	11/12/13	13.5/15/17	15.5/18/21	17/21/24	20/24/28	21/26/32	24/30/36	29/36/43	33/41/49
24x24	CFM	504	630	756	882	1008	1140	1260	1512	1755
	Throw	11.5/13/14.5	14.5/16/18	17/20/23	20/23/27	22/26/30	22/28/34	26/32/38	30/38/46	34/42/50
	NC	25	30	35	40	40	45	45	45>	45>
	NC	25	30	35	40	40	45	45	45>	45>

350 Series

Please refer to Footnote A & C below.

Size	Velocity	300	400	500	600	700	800	900	1000
Effective Area	Duct Pt	0.007	0.011	0.017	0.024	0.034	0.044	0.055	0.068
2x10	CFM	26.9	35.8	44.8	53.8	62.7	71.7	80.6	89.6
.089 ft ²	Throw	1.5/2/3	2/2.5/3.8	3/3.5/5	3/4/5.5	3.5/5/6.5	4/5.5/7.5	4.5/6/8.5	5/7/9.5
	Spread	2.5	3	4	5	5.5	6	7	8
	NC	<20	20	25	25	30	30	35	35
2x12	CFM	30.9	41.2	51.5	61.8	72.1	82.4	92.7	103
.102 ft ²	Throw	2/2.5/3.5	2.5/3/4.5	3/4/5.5	3.5/5/7	4/5.5/7.5	4.5/6.5/9	5/7/10.5	5.5/8/11.5
	Spread	3	3.5	4.5	5.5	6	7	8	9
	NC	<20	20	25	25	30	30	35	35
2x14	CFM	35.5	47.4	59.4	71.1	82.9	94.8	106.6	118.5
.117 ft ²	Throw	2/2.5/4	2.5/3.5/5	3/4.5/6.5	4/5.5/7.5	4.5/6.5/9	5/7/20/10	6/8/11.5	6.5/9/12.5
	Spread	3	4	5	5.5	6.5	7.5	8	9
	NC	<20	20	25	25	30	30	35	35
4x10	CFM	48.9	64.5	81.1	96.7	113.4	129.0	145.6	160.2
.171 ft ²	Throw	3.5/4/4.5	5/5.5/6	6.5/7.5/8.5	7/8.5/9.5	8.5/10.5/12	9.5/11.5/13	10/12.5/15	11/14/17.5
	Spread	3	4	5	6	7	8	10	11
	NC	<20	20	25	25	30	35	35	40
4x12	CFM	60.3	80.1	100.9	119.6	137.3	158.1	177.8	198.6
.199 ft ²	Throw	4.5/5/5.5	5.5/6.5/7	7/8.5/9.5	7.5/9/10.5	9.5/11/12.5	11/13.5/15.5		12.5/15.5/19
	Spread	3.5	5	6	7	8	9	10	12
	NC	<20	20	25	25	30	35	35	40
4x14	CFM	65.5	87.4	110.2	132.1	152.9	175.8	197.6	218.4
.226ft ²	Throw	4.5/5.5/6.5	6/7/8	7/8/9	8.5/10.5/12	10/11.5/13.5	11.5/13.5/16	12.5/15/18	13.5/16.5/20
	Spread	4	5	6	7	9	10	11	12
6x8	NC	<20	20	25	25	30	35	35	40
.174 ft ²	CFM	52	69	87	104	121	138	155	174
	Throw	3.5/4/4.5	5.5/6/6.5	6.5/7/7.5	7.5/9/10.5	8.5/10/11.5	10/12/14	11.5/14.5/17	12/15/18
	Spread	4.5	6	7	9	10	12	13	15
	NC	<20	20	25	30	35	35	40	40
6x10	CFM	71	95	118	141	166	190	212	237
.238 ft ²	Throw	4.5/5/5.5	6.5/7/7.5	7.5/8.5/9.5	8.5/10/11.5	10/12/14	11.5/13.5/15.5	12/15/18	13.5/17/20
	Spread	5	7	9	10.5	12	14	15	17
	NC	<20	20	25	30	35	40	40	40
6x12	CFM	85	113	140	169	197	225	255	282
.275 ft ²	Throw	5.5/6/6.5	6.5/7/7.5	8/9/10	9.5/11/12.5	11/13/15	13/15/17	13/17/20	15/19/22
	Spread	6	8	9	11	13	15	17	19
	NC	<20	20	25	30	35	40	40	45
6x14	CFM	105	140	175	210	245	281	315	351
.358 ft ²	Throw	5.5/6/6.5	7/8/9	9/10/11	10/12/14	12.5/14.5/17	14.5/17/20	15/19/22	17/21/25
	Spread	6	8	11	13	15	17	18	21
	NC	<20	20	25	30	35	40	40	45

FOOTNOTE A:
SIZE: Nominal size or the duct opening.

EFFECTIVE AREA: The space between the vanes actually utilized by the air.

VELOCITY: The actual velocity of the air through the vanes measured with a velometer or similar device.

DUCT Pt: The total pressure behind the register in the duct forcing that air through the register.

THROW: The throws noted in the tables are the distance from the register to where the air stream velocity has dropped to not under 100/75/50 F.P.M.

FOOTNOTE C:
NOISE CRITERIA: NC "A" scale.

- (1) Below NC25 extremely quiet.
- (2) Below NC30 Quiet Office.
- (3) Below NC35 Conference Rooms; normal voice 10-30 ft.
- (4) Below NC40 Conference Rooms; 6-12 ft. normal voice.
- (5) NC45 Conference Rooms; 3-6 ft. normal voice.

375 Series

Please refer to Footnote A & C below.

SIZE	Velocity	300	400	500	600	700	800	900	1000
Eff.Area	Duct Pt	0.007	0.011	0.017	0.024	0.034	0.044	0.055	0.068
21/4 x10	CFM	29	39	48	57	66	75	84	94
.091ft2	Throw	2/2/2002	2.5/3/3.5	2.5/3/3.5	3.5/4/4.5	4.5/5/6	4.5/5/6	5/6/2007	5.5/7/8.5
	Spread	3	4	5	7	8	9	10	11
	NC	<20	<20	20	25	25	25	30	35
21/4 x12	CFM	36	46	56	66	77	87	97	108
.111 ft2	Throw	2/2/2002	2.5/3/3.5	3.5/4/4.5	3.5/4/4.5	4.5/5/6	5/6/2007	5.5/7/8.4	5.5/7/8.5
	Spread	3	5	6	7	9	10	11	12
	NC	<20	<20	20	25	25	25	30	35
21/4 x14	CFM	41	53	65	77	90	103	115	128
.125 ft2	Throw	2.5/3/3.5	2.5/3/3.5	3.5/4/4.5	4.5/5/6	5/6/2007	6/7/2008	5.5/7/8.5	6.5/8/9.5
	Spread	4	5	7	8	10	11	12	13
	NC	<20	<20	20	25	25	25	30	35
4x10	CFM	52	68	85	100	118	135	150	166
.165 ft2	Throw	2.5/3/3.5	3.5/4/4.5	4.5/5/5.5	5/6/07	6/7/08	6/7/08	6.5/8/9.5	7/9/11
	Spread	4	6	8	9	11	12	14	16
	NC	<20	<20	20	25	25	30	30	35
4x12	CFM	66	86	107	127	143	164	184	210
.212 ft2	Throw	2.5/3/3.5	3.5/4/4.5	4.5/5/5.5	5/6/07	6/7/08	7/8/09	7/9/11	8/10/12
	Spread	4	7	9	10	12	14	16	17.5
	NC	<20	<20	20	25	25	30	30	35
4x14	CFM	74	95	119	141	163	190	220	245
.251 ft2	Throw	3.5/4/4.5	4.5/5/5.5	5.5/6/6.5	6/7/08	7/8/09	7.5/7/10.5	8/10/2012	9/11/2013
	Spread	6	8	10	11	13.5	15.5	17.5	19
	NC	<20	<20	20	25	25	30	30	35
6x10	CFM	82	112	138	163	194	219	250	275
.265 ft2	Throw	3.5/4/4.5	4.5/5/5.5	5.5/6/6.5	6/7/08	7/8/09	7.5/9/10.5	9/11/2013	9.5/12/14.5
	Spread	6	8	10	12	14	16	18	20
	NC	<20	<20	20	25	30	30	30	35
6x12	CFM	102	133	168	204	235	270	301	337
.325 ft2	Throw	3.5/4/4.5	4.5/5/5.5	6.5/7/7.5	7/8/09	7.5/9/10.5	8.5/10/11.5	9.5/12/14.5	10.5/13/15.5
	Spread	7	9	11	13	15.5	17.5	20	22
	NC	<20	<20	20	25	30	30	30	35
6x14	CFM	117	158	199	240	281	316	357	398
.391 ft2	Throw	4.5/5/5.5	5.5/6/6.5	6.5/7/7.5	7.5/9/10.5	8.5/10/11.5	9.5/11/12.5	10.5/13/15.5	11.5/14.5/17
	Spread	8	10	12	14.5	17.5	19.5	22	24
	NC	<20	<20	20	25	30	30	30	35

FOOTNOTE A:

SIZE: Nominal size or the duct opening.

EFFECTIVE AREA: The space between the vanes actually utilized by the air.

VELOCITY: The actual velocity of the air through the vanes measured with a velometer or similar device.

DUCT Pt: The total pressure behind the register in the duct forcing that air through the register.

THROW: The throws noted in the tables are the distance from the register to where the air stream velocity has dropped to not under 100/75/50 F.P.M.

FOOTNOTE C:

NOISE CRITERIA: NC "A" scale.

- (1) Below NC25 extremely quiet.
- (2) Below NC30 Quiet Office.
- (3) Below NC35 Conference Rooms; normal voice 10-30 ft.
- (4) Below NC40 Conference Rooms; 6-12 ft. normal voice.
- (5) NC45 Conference Rooms; 3-6 ft. normal voice.

AFP Series

Please refer to Footnote A & C on page E10.

SIZE	Velocity	300	400	500	600	700	800	900	1000
Eff.Area	Duct Pt	.007	.011	.017	.024	.034	.044	.055	.068
21/4 x10	CFM	28	34	39	45	50	62	67	73
.084 ft ²	Throw	2/2/2	2/2.5/3	2.5/3/3.5	4.5/5/6	5/6/7	6/7/8	6.5/8/9.5	7/8.5/10
	NC	<20	25	25	30	30	30	35	35
21/4 x12	CFM	34	45	50	62	67	78	84	95
.102 ft ²	Throw	3.5/4/4.5	4/4.5/5	4.5/5/5.5	5/6/7	5/6/7	7/8/9	6.5/8/9.5	7/9/11
	NC	<20	25	25	30	30	30	35	35
21/4 x14	CFM	39	50	56	67	73	84	95	101
.121 ft ²	Throw	4/4.5/5	4.5/5/5.5	5/5.5/6	5/6/7	6/7/8	7/8/9	7.5/9.5/11.5	8/10/12
	NC	<20	25	25	30	30	30	35	35
4x10	CFM	50	62	78	95	112	129	146	162
.158 ft ²	Throw	3.5/4/4.5	4.5/5/5.5	5.5/6/6.5	7/8/9	7.5/9/10.5	8/9.5/11	9/11/13	9.5/12/14.5
	NC	<20	25	25	30	30	30	35	40
4x12	CFM	67	84	101	123	140	168	185	207
.195 ft ²	Throw	4/4.5/5	5.5/6/6.5	6.5/7/7.5	7/8.5/10	8/9.5/11	9.5/11/12.5	9.5/12/14.5	11.5/14.5/17.5
	NC	<20	25	25	30	30	35	35	40
4x14	CFM	73	90	118	140	162	185	207	235
.232 ft ²	Throw	4/4.5/5	5.5/6/6.5	7/8/9	8/9.5/11	9.5/11/12.5	10/12/14	10.5/13/15.5	11.5/14.5/17.5
	NC	<20	25	30	30	30	35	35	40
6x10	CFM	78	106	140	168	196	218	246	274
.245 ft ²	Throw	5.5/6/6.5	5.5/6/6.5	7/8/9	8/9.5/11	9.5/11/12.5	/12/14	11.3/14.5/17	13/16/19
	NC	<20	25	30	30	30	35	40	40
6x12	CFM	101	134	168	202	235	269	302	336
.300 ft ²	Throw	5.5/6/6.5	6.5/7/7.5	8/9/10	8.5/10/11.5	10/12/14	12.5/14.5/17	13/16/19	14.5/18/22
	NC	<20	25	30	30	35	35	40	40
6x14	CFM	118	162	202	241	280	319	358	403
.353 ft ²	Throw	5.5/6/6.5	7/8/9	8.5/9.5/10/5	9.5/11/12.5	11.5/13.5/15.5	13.5/16/18	14.5/18/22	16/20/24
	NC	<20	30	30	30	35	35	40	40
8x14	CFM	159	219	273	325	378	431	483	544
.353 ft ²	Throw	5.5/7/8.5	7.5/9.5/11.5	9/11.5/14	10.5/13/15.5	13/16/19	15/19/23	17/22/26	19/24/29
	NC	<20	30	30	30	35	35	40	40

845 Series

Please refer to Footnote A & C on page E10.

SIZE	Velocity	300	400	500	600	700	800	900	1000	1200
Eff.Area	Duct Pt	.007	.011	.017	.024	.034	.044	.055	.068	.100
8x4	CFM	23	30	38	45	53	60	68	75	90
.083 ft ²	Throw C	3/3.5/4	4.5/5/5.5	6/6.5/7	7/8/9	7.5/9/10.5	9/10.5/12	9.5/12/14.5	10.5/13/15.5	13/16/19
	Throw S	2.5/3/3.5	2.5/3/3.5	2.5/3/3.5	2.5/3/3.5	3/3.5/4	3.5/4/4.5	3.5/4.5/5.5	4/5/6	5/6.5/8
	NC	<20	20	25	25	30	30	35	35	40
10x4	CFM	28	38	48	57	66	75	85	94	113
.104 ft ²	Throw C	3/3.5/4	4.5/5/5.5	6/6.5/7	7/8/9	8/9.5/11	9.5/11/12.5	9.5/12/14.5	10.5/13/15.5	13/16/19
	Throw S	2/2/2	2.5/3/3.5	3.5/4/4.5	4.5/5/6	4.5/5.5/6.5	5/6/7	5.5/7/8.5	6.5/8/9.5	7/9/11
	NC	<20	20	25	25	30	30	35	35	40
12x4	CFM	36	48	60	72	85	97	109	121	145
.133 ft ²	Throw C	4/4.5/5	5.5/6/6.5	7/7.5/8.5	7.5/9/10.5	9/10.5/12	10/12/14	11/13.5/16	12/15/18	14.5/18/22
	Throw S	2.5/3/3.5	3/3.5/4	3.5/4/4.5	4.5/5/6	5/6/7	6/7/8	6.5/8/9.5	7/9/11	8/10/12
	NC	<20	20	25	25	30	35	35	40	40
14x4	CFM	42	57	72	86	100	114	129	143	171
.157 ft ²	Throw C	4/4.5/5	5.5/6/6.5	7/7.5/8.5	7.5/9/10.5	9/10.5/12	10/12/14	11/13.5/16	12/15/18	14.5/18/22
	Throw S	2.5/3/3.5	3.5/4/4.5	4.5/5/5.5	5/6/7	6/7/8	7/8/9	7/9/11	8/10/12	9.5/12/14.5
	NC	<20	20	25	25	30	35	35	40	40
10x6	CFM	51	69	87	104	121	138	156	173	207
.173 ft ²	Throw C	4.5/5/5.5	6.5/7/7.5	8/9/10	9/10.5/12	10/12/14	12/14/16	13/16/19	14/18/21	17/21/25
	Throw S	2.5/3/3.5	3.5/4/4.5	4.5/5/5.5	5/6/7	6/7/8	7/8/9	7.5/9.5/11.5	9/11/13	10.5/13/15.5
	NC	<20	20	25	25	30	35	35	40	40
12x6	CFM	61	81	101	121	142	162	182	202	243
.202 ft ²	Throw C	5/5.5/6	6.5/7/7.5	7.5/8.5/9.5	8.5/10/11.5	10/12/14	12/14/16	12.5/15.5/19	13.5/17/20	16/20/24
	Throw S	3/3.5/4	4.5/5/5.5	6/6.5/7	7/8/9	7.5/9/10.5	8.5/10/11.5	9/11.5/15	10.5/13/15.5	12/15/18
	NC	<20	20	25	30	35	35	35	40	40
14x6	CFM	71	101	127	152	177	202	228	253	304
.255 ft ²	Throw C	5.5/6/6.5	7/8/9	9/10/11	10/12/14	12/14/16	13.5/16/18	14.5/18/22	16/20/24	19/24/29
	Throw S	4.5/5/5.5	5.5/6/6.5	6.5/7/7.5	7/8/9	8/9.5/11	9.5/11/12.5	10/12.5/15	11/14/17	13.5/17/20
	NC	<20	20	25	30	35	35	35	40	40
12x8	CFM	90	120	150	179	209	239	269	299	359
.305 ft ²	Throw C	5.5/6/6.5	7/8/9	9/10/11	10/12/14	12/14/16	14/17/19	15/19/22	16/21/25	20/25/30
	Throw S	5/5.5/6	5.5/6/6.5	7/8/9	8/9.5/11	9.5/11/12.5	10.5/12.5/14.5	11/14/17	12/15/18	15/19/23
	NC	<20	20	25	30	35	35	40	40	45
14x8	CFM	110	147	184	221	258	294	331	368	442
.369 ft ²	Throw C	6.5/7/7.5	8.5/9.5/10.5	11.5/13/14.5	12/14/16	14/17/19	16/19/22	17/22/26	19/24/29	22/28/34
	Throw S	5/5.5/6	6.5/7/7.5	7.5/8.5/9.5	8.5/10/11.5	10/12/14	11.5/13.5/15.5	12/15/18	13.5/17/20	16/20/24
	NC	<20	20	25	30	35	40	40	40	45

* Throw C = Throw Center/ Throw S = Throw Sides

833 Series

Size	Velocity	300	400	500	600	700	800	900	1000	1200
Eff.Area	Duct Pt	0.006	0.01	0.016	0.023	0.031	0.04	0.051	0.063	0.09
8x4	CFM	36	48	60	72	84	96	108	120	144
0.12 ft ²	Throw	2/2/2	2.5/3/3.5	3.5/4/4.5	4.5/5/6	5/6/7	6/7/8	6/7.5/9	6.5/8/9.5	8/10/12
	Spread	4	7	8	10	11	13	14	17	20
	NC	<20	20	25	25	30	30	35	35	40
10x4	CFM	47	62	78	94	109	125	140	156	187
0.156 ft ²	Throw	2/2.5/3	3.5/4/4.5	4.5/5/5.5	5/6/7	6/7/8	6/7/8	6.5/8/9.5	7/9/11	9/11/13
	Spread	5.5	8	9	11	13	15	17	19	22
	NC	<20	20	25	25	30	35	35	40	40
12x4	CFM	58	77	96	115	134	154	173	192	230
0.192 ft ²	Throw	2.5/3/3.5	3.5/4/4.5	4.5/5/5.5	5/6/7	6/7/8	7/8/9	7/9/11	8/10/12	9.5/12/14.5
	Spread	6	8	10	12	14	16	18	20	24
	NC	<20	20	25	25	30	35	35	40	40
14x4	CFM	68	91	114	137	160	182	205	228	274
0.228 ft ²	Throw	2.5/3/3.5	3.5/4/4.5	4.5/5/5.5	6/7/8	7/8/9	7/9/11	8/10/12	9/11/13	10.5/13/15.5
	Spread	7	9	11	13	15	17	19	22	26
	NC	<20	20	25	25	30	35	35	40	40
10x6	CFM	300	400	500	600	700	800	900	1000	1200
0.258 ft ²	Throw	2/2/2	2.5/3/3.5	3.5/4/4.5	4.5/5/6	5/6/7	6/7/8	6/7.5/9	6.5/8/9.5	8/10/12
	Spread	4	7	8	10	11	13	14	17	20
	NC	<20	20	25	25	30	35	35	40	40
12x6	CFM	300	400	500	600	700	800	900	1000	1200
0.318 ft ²	Throw	2/2.5/3	3.5/4/4.5	4.5/5/5.5	5/6/7	6/7/8	6/7/8	6.5/8/9.5	7/9/11	9/11/13
	Spread	5.5	8	9	11	13	15	17	19	22
	NC	<20	20	25	30	35	35	35	40	40
14x6	CFM	300	400	500	600	700	800	900	1000	1200
0.378 ft ²	Throw	2.5/3/3.5	3.5/4/4.5	4.5/5/5.5	5/6/7	6/7/8	7/8/9	7/9/11	8/10/12	9.5/12/14.5
	Spread	6	8	10	12	14	16	18	20	24
	NC	<20	20	25	30	35	35	35	40	40
12x8	CFM	300	400	500	600	700	800	900	1000	1200
0.436 ft ²	Throw	2.5/3/3.5	3.5/4/4.5	4.5/5/5.5	6/7/8	7/8/9	7/9/11	8/10/12	9/11/13	10.5/13/15.5
	Spread	7	9	11	13	15	17	19	22	26
	NC	<20	20	25	30	35	35	40	40	45
14x8	CFM	300	400	500	600	700	800	900	1000	1200
0.518 ft ²	Throw	2/2/2	2.5/3/3.5	3.5/4/4.5	4.5/5/6	5/6/7	6/7/8	6/7.5/9	6.5/8/9.5	8/10/12
	Spread	4	7	8	10	11	13	14	17	20
	NC	<20	20	25	30	35	40	40	40	45

945 Series

Please refer to Footnote A & C on page

SIZE	Velocity	300	400	500	600	700	800	900	1000	1200
Eff.Area	Duct Pt	.007	.011	.017	.024	.034	.044	.055	.068	.100
8x4	CFM	40	53	67	79	93	105	119	131	158
.145 ft ²	Throw C	4.5/5/6	6.5/7.5/8	9/10/10.5	10.5/12/13.5	11/13/16	13.5/16/18	14/18/22	16/20/23	20/24/28
	Throw S	4/4.5/5	4/4.5/5	4/4.5/5	4/4.5/5	4.5/5/6/	5/6/7	5/6/7	6/8/9	7.5/10/12
	NC	<20	20	25	25	30	30	35	35	40
10x4	CFM	49	67	84	100	116	131	149	165	198
.190 ft ²	Throw C	4.5/5/6	6.5/7.5/8	9/10/10.5	10.5/12/13.5	12/14/17	14/17/19	14/18/22	16/20/23	20/24/28
	Throw S	3/3/3	4/4.5/5	5/6/7	6.5/7.5/9	6.5/7.5/10	7.5/9/10.5	8/10.5/13	10/12/14	10.5/13.5/17
	NC	<20	20	25	25	30	30	35	35	40
12x4	CFM	63	84	105	126	149	170	191	212	254
.230 ft ²	Throw C	6/7/7.5	8/9/10	10.5/11/13	11/13.5/16	13.5/16/18	15/18/21	17/20/24	18/23/27	22/27/33
	Throw S	4/4.5/5	4.5/5/5	5/6/7	6.5/7.5/9	7.5/9/10.5	9/10.5/12	10/12/14	10.5/13.5/17	12/15/18
	NC	<20	20	25	25	30	35	35	40	40
14x4	CFM	74	100	126	151	175	20	226	250	299
.265 ft ²	Throw C	6/7/7.5	8/9/10	10.5/11/13	11/13.5/16	13.5/16/18	15/18/21	17/20/24	18/23/27	22/27/33
	Throw S	4/4.5/5	5/6/7	7/7.5/8	7.5/9/10.5	9/10.5/12	10.5/12/13.5	10.5/13.5/17	12/15/18	14/18/22
	NC	<20	20	25	25	30	35	35	40	40
10x6	CFM	89	121	152	182	212	242	273	303	362
.295 ft ²	Throw C	7/7.5/8	10/10.5/11	12/13.5/15	13.5/16/18	15/18/21	18/21/24	20/24/29	21/27/32	26/32/38
	Throw S	4/4.5/5	5/6/7	7/7.5/8	7.5/9/10.5	9/10.5/12	10.5/12/13.5	11/14/17	13.5/17/20	16/20/23
	NC	<20	20	25	25	30	35	35	40	40
12x6	CFM	107	142	177	212	249	284	319	354	425
.360 ft ²	Throw C	7.5/8/9	10/10.5/11	11/13/14	13/15/17	15/18/21	18/21/24	19/23/29	20/26/30	24/30/36
	Throw S	4.5/5/6	7/7.5/8	9/10/10.5	1.5/12/13.5	11/13.5/16	13/15/17	13.5/17/23	16/20/23	18/23/27
	NC	<20	20	25	30	35	35	35	40	40
14x6	CFM	124	177	222	266	310	354	399	443	532
.420 ft ²	Throw C	8/9/10	10.5/12/13.5	13.5/15/17	15/18/21	18/21/24	20/24/27	22/27/33	24/30/36	29/36/44
	Throw S	7/7.5/8	8/9/10	10/1.5/11	10.5/12/13.5	12/14/17	14/17/19	15/19/23	17/21/26	20/26/30
	NC	<20	20	25	30	35	35	35	40	40
12x8	CFM	158	210	263	313	366	418	471	523	628
.480 ft ²	Throw C	8/9/10	10.5/12/13.5	13.5/15/17	15/18/21	18/21/24	21/26/29	23/29/33	24/32/38	30/38/45
	Throw S	7.5/8/9	8/9/10	10.5/12/13.5	12/14/17	14/17/18	16/19/22	17/21/26	18/23/27	23/29/35
	NC	<20	20	25	30	35	35	40	40	45
14x8	CFM	193	257	322	387	452	515	579	644	774
.560 ft ²	Throw C	10/10.5/11	13/14/16	17/20/22	18/21/24	21/26/29	24/29/33	26/33/39	29/36/44	33/42/51
	Throw S	7.5/8/9	10/10.5/11	11/13/14	13/15/17	15/18/21	17/20/23	18/23/27	20/26/30	24/30/36
	NC	<20	20	25	30	35	40	40	40	45

* Throw C = Throw center, Throw S = Throw sides

850 Series

Please refer to Footnote A & C below.

Size	Velocity	300	400	500	600	700	800	900	1000	1200
Eff. Area	Duct Pt	0.006	0.01	0.016	0.023	0.031	0.04	0.051	0.063	0.09
6x4 .08sqft	CFM	24	32	40	48	56	64	72	80	96
	Throw	2/2/2	2/2.5/3	2.5/3/3.5	3/3.5/4	3.5/4/4.5	4.5/5/6	4.5/5.5/6.5	5/6/7	6/7.5/9
	Spread	3.5	5	8	6	8	10	11	12	15
8x4 .112 sqft	NC	<20	20	25	25	30	30	35	35	40
	CFM	34	45	56	67	78	90	101	112	134
	Throw	2/2/2	2.5/3/3.5	3.5/4/4.5	4/4.5/5	4.5/5/6	5/6/7	5/6.5/8	6/7.5/9	7/9/11
10x4 .144 sqft	Spread	4	6	7	9	10	12	13	15	18
	NC	<20	20	25	25	30	30	35	35	40
	CFM	43	58	72	86	101	115	130	144	173
12x4 .176sqft	Throw	2/2.5/3	2.5/3/3.5	3.5/4/4.5	4.5/5/6	5/6/7	6/7/8	6/7.5/9	6.5/8/9.5	8/10/12
	Spread	5	7	8.5	10	12	14	15	17	20
	NC	<20	20	25	25	30	30	35	35	40
14x4 .208sqft	CFM	53	70	88	106	123	141	158	176	211
	Throw	2.5/3/3.5	3.5/4/4.5	4.5/5/5.5	5/6/7	6/7/8	6/7/8	6.5/8/9.5	7/9/11	9/11/13
	Spread	5.5	7	9	11	13	15	17	19	22
8x6 .182 sqft	NC	<20	20	25	25	30	35	35	40	40
	CFM	62	83	104	125	146	166	187	208	250
	Throw	2.5/3/3.5	3.5/4/4.5	4.5/5/5.5	5/6/7	6/7/8	7/8/9	7/9/11	8/10/12	9.5/12/14.5
10x6 .234 sqft	Spread	6	8	10	12	14	16	18	20	24
	NC	<20	20	25	25	30	35	35	40	40
	CFM	70	92	117	140	163	187	210	234	280
12x6 .286sqft	Throw	2.5/3/3.5	3.5/4/4.5	4.5/5/5.5	6/7/8	7/8/9	7/9/11	8/10/12	9/11/13	10.5/13/15.5
	Spread	6	9	11	13	15	17	19	22	26
	NC	<20	20	25	25	30	35	35	40	40
14x6 .338sqft	CFM	85	114	143	171	200	228	257	286	343
	Throw	2/2/2	3.5/4/4.5	4.5/5/5.5	6/7/8	7/8/9	7.5/9/10.5	8.5/10.5/12.5	9.5/12/14.5	11/14/17
	Spread	5	7	9	14	16	19	21	23	26
16x6 .390sqft	NC	<20	20	25	30	35	35	40	40	45
	CFM	101	135	169	202	236	270	304	338	405
	Throw	3/3.5/4	4.5/5/5.5	5.5/6/6.5	6/7/8	7/8/9	8.5/10/11.5	9/11/13	9.5/12/14.5	11.5/14.5/17
18x6 .442 sqft	Spread	7	10	12	14.5	17	19	22	24	29
	NC	<20	20	25	30	35	35	40	40	40
	CFM	117	156	195	235	273	312	351	390	250
20x6 .494 sqft	Throw	9	12	16	18	21	24	26	30	36
	Spread	9	12	16	18	21	24	26	30	36
	NC	<20	20	25	30	35	35	40	40	45
24x6 .611sqft	CFM	132	176	221	265	309	353	397	442	530
	Throw	4.5/5/5.5	6.5/7/7.5	7/8/9	8.5/10/11.5	10/11/14	11/13/15	12/15/18	13/16/19	16/20/24
	Spread	10	13	16	20	23	26	30	33	39
8x8 .238sqft	NC	<20	20	25	25	30	35	40	40	40
	CFM	148	197	247	269	345	395	444	494	592
	Throw	4.5/5/5.5	6.5/7/7.5	7/8/9	8.5/10/11.5	10/11/14	11/13/15	12/15/18	13/16/19	16/20/24
10x8 .306sqft	Spread	10	13	16	20	23	26	30	33	39
	NC	<20	20	25	30	35	40	40	40	45
	CFM	183	244	305	366	427	488	549	611	733
12x8 .374sqft	Throw	4.5/5/5.5	6.5/7/7.5	7/8/9	8.5/10/11.5	10/11/14	11/13/15	12/15/18	13/16/19	16/20/24
	Spread	10	13	16	20	23	26	30	33	39
	NC	<20	20	25	30	35-40	40	40-45	40-45	>45
16x8 .510 sqft	CFM	71	95	119	142	166	190	214	238	285
	Throw	3/3.5/4	4.5/5/5.5	5.5/6/6.5	6/7/8	7/8/9	7.5/9/10.5	9/11/13	9.5/12/14.5	11/14/17
	Spread	7	9.5	12	14	16	19	21	24	28
18x8 .578sqft	NC	<20	20	25	25	30	30	35	40	40
	CFM	91	122	153	183	214	244	275	306	367
	Throw	3.5/4/4.5	5/5.5/6	6.45/7/7.5	7/8/9	8.5/10/11.5	9.5/11/12.5	9.5/12/14.5	11/14/17	13.5/17/20
12x8 .374sqft	Spread	8	11	14	17	20	22	24	28	33
	NC	<20	20	25	30	35	35	40	40	45
	CFM	112	149	187	224	261	299	336	374	448
16x8 .510 sqft	Throw	4/4.5/5	5.5/6/6.5	7/7.5/8.5	7.5/9/10.5	8.5/10/11.5	10/12/14	11/14/18	12/15/18	14.5/18/22
	Spread	9	12	16	18	21	24	26	30	36
	NC	<20	20	25	30	35	35	40	40	45
18x8 .578sqft	CFM	153	204	255	306	357	408	459	510	612
	Throw	4.5/5/5.5	6.5/7/7.5	7/8/9	8.5/10/11.5	10/11/14	11/13/15	12/15/18	13/16/19	16/20/24
	Spread	10	13	16	20	23	26	30	33	39
18x8 .578sqft	NC	<20	20	25	30	35	40	40	40	45
	CFM	173	231	289	346	404	462	520	578	693
	Throw	4.5/5/5.5	6.5/7/7.5	7/8/9	8.5/10/11.5	10/12/14	11/13/15	12/15/18	13/16/19	16/20/24
18x8 .578sqft	Spread	10	13	16	20	23	26	30	33	39
	NC	<20	20	25	30	35-40	40	40-45	40-45	>45

FOOTNOTE A: **SIZE:** Nominal size or the duct opening. **EFFECTIVE AREA:** The space between the vanes actually utilized by the air. **VELOCITY:** The actual velocity of the air through the vanes measured with a velometer or similar device. **DUCT Pt:** The total pressure behind the register in the duct forcing that air through the register. **THROW:** The throws noted in the tables are the distance from the register to where the air stream velocity has dropped to not under 100/75/50 F.P.M.

FOOTNOTE B: **SIZE:** Nominal size or the duct opening. **EFFECTIVE AREA:** The space between the vanes actually utilized by the air. **VELOCITY:** The actual velocity of the air through the vanes measured with a velometer or similar device. **DUCT Ps:** The static pressure in the duct behind the grille. The static load on the fan chargeable against that grille. Velometer readings are taken between grille vanes giving actual velocity.

FOOTNOTE C: NOISE CRITERIA: NC "A" scale. (1) Below NC25 extremely quiet. (2) Below NC30 Quiet Office. (3) Below NC35 Conference Rooms; normal voice 10-30 ft. (4) Below NC40 Conference Rooms; 6-12 ft. normal voice. (5) NC45 Conference Rooms; 3-6 ft. normal voice.

855 Series

Please refer to Footnote A & C on page E14.

SIZE	Velocity	300	400	500	600	700	800	900	1000	1200
Eff.Area	Duct Pt	.007	.011	.017	.024	.034	.044	.055	.068	.100
10x6	CFM	59	79	98	118	138	157	175	197	236
.186 ft ²	Throw	2.5/3/3.5	3.5/4/4.5	4.5/5/5.5	6/7/8	7/8/9	7.5/9/10.5	8/10/12	9/11/13	10.5/13/15.5
	Spread	6	9	11	13	15	17	19	22	26
	NC	<20	20	25	25	30	35	35	40	40
12x6	CFM	69	92	115	138	161	184	205	230	276
.224 ft ²	Throw	2/2/2	3.5/4/4.5	4.5/5/5.5	6/7/8	7/8/9	7.5/9/10.5	9/11/13	9.5/12/14.5	11/14/17
	Spread	5	7	9	14	16	19	21	23	28
	NC	<20	20	25	30	35	35	35	40	40
14x6	CFM	73	97	121	146	170	194	225	243	291
.289 ft ²	Throw	3/3.5/4	4.5/5/5.5	5.5/6/6.5	6/7/8	7/8/9	8.5/10/11.5	9/11/13	9.5/12/14.5	11.5/14.5/17
	Spread	7	10	12	14.5	17	19	22	24	29
	NC	<20	20	25	30	35	35	35	40	40

1100 Series

Please refer to Footnote B on page E14.

SIZE	Eff.Area	Velocity	400	500	600	700	800	900	1000
		Duct Ps	.032	.048	.070	.092	.120	.140	.160
14x6	.74 ft ²	CFM	225	280	340	450	390	505	560
14x8	.78 ft ²	CFM	292	365	440	510	585	655	730
14x10	.85 ft ²	CFM	380	475	570	665	760	855	950
20x6	.88 ft ²	CFM	350	438	525	613	700	788	875
20x8	1.14 ft ²	CFM	455	569	735	797	910	1024	1138
20x10	1.29 ft ²	CFM	510	640	770	895	1025	1150	1280
20x12	1.44 ft ²	CFM	570	713	855	998	1140	1328	1425
24x6	.85 ft ²	CFM	380	475	570	665	760	855	950
24x8	1.29 ft ²	CFM	510	640	770	895	1025	1150	1280
24x10	1.44 ft ²	CFM	570	713	855	998	1140	1328	1425
24x12	1.72 ft ²	CFM	680	850	1020	1190	1360	1530	1700
30x6	1.09 ft ²	CFM	430	538	645	753	860	968	1075
30x8	1.44 ft ²	CFM	570	713	855	998	1140	1328	1425
30x10	2.02 ft ²	CFM	800	1000	1200	1400	1600	1800	2000
30x12	2.12 ft ²	CFM	840	1050	1260	1470	1680	1890	2100

1133 Series

Please refer to Footnote B on page E14.

SIZE	Eff.Area	Velocity	300	400	500	600	700	800	900	1000	1200	1400
		Duct Ps	.004	.011	.014	.023	.031	.040	.051	.062	.089	.122
14x6	.304 ft ²	CFM	94	122	150	178	209	239	272	305	371	435
14x8	.416 ft ²	CFM	127	166	205	244	286	327	372	416	505	593
20x6	.424 ft ²	CFM	129	169	209	248	291	334	379	424	514	646
20x8	.578 ft ²	CFM	177	231	285	339	397	455	517	578	703	826
24x6	.518 ft ²	CFM	158	207	256	304	356	407	463	518	628	738
24x8	.706 ft ²	CFM	216	282	348	414	485	555	631	706	857	1006
30x6	.646 ft ²	CFM	198	259	320	380	444	508	578	647	784	922
30x8	.882 ft ²	CFM	270	353	436	518	606	693	788	882	1071	1258

1150 Series

Please refer to Footnote B on page

SIZE	Eff.Area	Velocity	300	400	500	600	700	800	900	1000	1200	1400
		Duct Ps	.007	.011	.017	.023	.031	.040	.051	.062	.089	.122
14x6	.334 ft ²	CFM	103	134	165	196	230	263	299	336	408	479
14x8	.458 ft ²	CFM	140	183	226	268	315	360	409	458	556	652
20x6	.466 ft ²	CFM	142	186	230	273	320	367	416	466	565	711
20x8	.636 ft ²	CFM	195	254	314	373	437	501	569	636	773	909
24x6	.570 ft ²	CFM	174	228	282	334	392	448	509	570	691	812
24x8	.777 ft ²	CFM	238	310	383	455	534	610	694	777	943	1107
30x6	.711 ft ²	CFM	218	285	352	418	488	559	636	712	862	1014
30x8	.970 ft ²	CFM	297	388	480	570	667	762	867	970	1178	1384

1050 or 1075 Series

		Free	Velocity	300	400	600	800	1000	1200	1400	1600
Size	Eff Area	Area	Duct Ps	0.007	0.01	0.023	0.04	0.064	0.09	0.123	0.16
10x4	0.14 ft ²	28	CFM	38	56	84	112	140	168	196	224
10x6	.220 ft ²	44	CFM	59	88	132	176	220	264	308	352
10x8	.300 ft ²	59	CFM	80	120	180	240	300	360	420	480
10x10	0.38 ft ²	75	CFM	102	152	228	304	380	456	532	608
10x12	0.46 ft ²	91	CFM	123	184	276	368	460	552	644	736
10x14	0.54 ft ²	107	CFM	145	216	324	432	540	648	756	864
10x16	0.62 ft ²	123	CFM	166	248	372	496	620	744	868	992
10x20	0.78 ft ²	155	CFM	209	312	468	624	780	936	1092	1248
12x4	0.182 ft ²	34	CFM	49	72.8	109.2	145.6	182	218.4	254.8	291.2
12x6	0.286 ft ²	54	CFM	77	114.4	171.6	228.8	286	343.2	400.4	457.6
12x8	0.39 ft ²	74	CFM	105	156	234	312	390	468	546	624
12x10	0.494 ft ²	93	CFM	132	197.6	296.4	395.2	494	592.8	691.6	790.4
12x12	0.598 ft ²	113	CFM	160	239.2	358.8	478.4	598	717.6	837.2	956.8
12x14	0.702 ft ²	133	CFM	188	280.8	421.2	561.6	702	842.4	982.8	1123.2
12x16	0.806 ft ²	152	CFM	216	322.4	483.6	644.8	806	967.2	1128.4	1289.6
12x18	0.91 ft ²	172	CFM	244	364	546	728	910	1092	1274	1456
12x20	1.014 ft ²	192	CFM	272	405.6	608.4	811.2	1014	1216.8	1419.6	1622.4
14x4	0.21 ft ²	40	CFM	56	84	126	168	210	252	294	336
14x6	0.33 ft ²	63	CFM	88	132	198	264	330	396	462	528
14x8	0.45 ft ²	86	CFM	121	180	270	360	450	540	630	720
14x10	0.57 ft ²	106	CFM	153	228	342	456	570	684	798	912
14x12	0.69 ft ²	131	CFM	185	276	414	552	690	828	966	1104
14x14	0.81 ft ²	154	CFM	217	324	486	648	810	972	1134	1296
14x16	0.93 ft ²	177	CFM	249	372	558	744	930	1116	1302	1488
14x18	1.05 ft ²	200	CFM	281	420	630	840	1050	1260	1470	1680
14x20	1.17 ft ²	223	CFM	314	468	702	936	1170	1404	1638	1872
16x6	0.352 ft ²	69	CFM	94	140.8	211.2	281.6	352	422.4	492.8	563.2
16x8	0.48 ft ²	94	CFM	129	192	288	384	480	576	672	768
16x10	0.608 ft ²	119	CFM	163	243.2	364.8	486.4	608	729.6	851.2	972.8
16x12	0.736 ft ²	144	CFM	197	294.4	441.6	588.8	736	883.2	1030.4	1177.6
16x14	0.864 ft ²	169	CFM	232	345.6	518.4	691.2	864	1036.8	1209.6	1382.4
16x16	0.992 ft ²	194	CFM	266	396.8	595.2	793.6	992	1190.4	1388.8	1587.2
16x20	1.248 ft ²	244	CFM	334	499.2	748.8	998.4	1248	1497.6	1747.2	1996.8
18x6	0.429 ft ²	81	CFM	115	171.6	257.4	343.2	429	514.8	600.6	686.4
18x8	0.585 ft ²	111	CFM	157	234	351	468	585	702	819	936
18x10	0.741 ft ²	140	CFM	199	296.4	444.6	592.8	741	889.2	1037.4	1185.6
18x12	0.897 ft ²	170	CFM	240	358.8	538.2	717.6	897	1076.4	1255.8	1435.2
18x14	1.053 ft ²	199	CFM	282	421.2	631.8	842.4	1053	1263.6	1474.2	1684.8
18x16	1.209 ft ²	229	CFM	324	483.6	725.4	967.2	1209	1450.8	1692.6	1934.4
18x18	1.365 ft ²	258	CFM	366	546	819	1092	1365	1638	1911	2184
18x20	1.521 ft ²	288	CFM	408	608.4	912.6	1216.8	1521	1825.2	2129.4	2433.6

1050 or 1075 Series

	Free	Free	Velocity	300	400	600	800	1000	1200	1400	1600
Size	Eff Area	Area	Duct Ps	0.007	0.01	0.023	0.04	0.064	0.09	0.123	0.16
20x6	0.44 ft ²	95	CFM	118	176	264	352	440	528	616	704
20x8	0.6 ft ²	130	CFM	161	240	360	480	600	720	840	960
20x10	0.76 ft ²	164	CFM	204	304	456	608	760	912	1064	1216
20x12	0.92 ft ²	199	CFM	247	368	552	736	920	1104	1288	1472
20x14	1.08 ft ²	233	CFM	289	432	648	864	1080	1296	1512	1728
20x16	1.24 ft ²	268	CFM	332	496	744	992	1240	1488	1736	1984
20x18	1.4 ft ²	302	CFM	375	560	840	1120	1400	1680	1960	2240
20x20	1.56 ft ²	337	CFM	418	624	936	1248	1560	1872	2184	2496
20x24	1.88 ft ²	406	CFM	504	752	1128	1504	1880	2256	2632	3008
20x30	2.36 ft ²	510	CFM	632	944	1416	1888	2360	2832	3304	3776
24x6	0.572 ft ²	120	CFM	153	228.8	343.2	457.6	572	686.4	800.8	915.2
24x8	0.78 ft ²	164	CFM	209	312	468	624	780	936	1092	1248
24x10	0.988 ft ²	207	CFM	265	395.2	592.8	790.4	988	1185.6	1383.2	1580.8
24x12	1.196 ft ²	251	CFM	321	478.4	717.6	956.8	1196	1435.2	1674.4	1913.6
24x14	1.404 ft ²	294	CFM	376	561.6	842.4	1123.2	1404	1684.8	1965.6	2246.4
24x16	1.612 ft ²	338	CFM	432	644.8	967.2	1289.6	1612	1934.4	2256.8	2579.2
24x18	1.82 ft ²	382	CFM	488	728	1092	1456	1820	2184	2548	2912
24x20	2.028 ft ²	425	CFM	544	811.2	1216.8	1622.4	2028	2433.6	2839.2	3244.8
24x24	2.44 ft ²	513	CFM	655	977.6	1466.4	1955.2	2444	2932.8	3421.6	3910.4
24x30	3.068 ft ²	641	CFM	822	1227.2	1840.8	2454.4	3068	3681.6	4295.2	4908.8
30x6	0.715 ft ²	150	CFM	192	286	429	572	715	858	1001	1144
30x8	0.975 ft ²	206	CFM	261	390	585	780	975	1170	1365	1560
30x10	1.235 ft ²	259	CFM	331	494	741	988	1235	1482	1729	1976
30x12	1.495 ft ²	314	CFM	401	598	897	1196	1495	1794	2093	2392
30x14	1.755 ft ²	368	CFM	470	702	1053	1404	1755	2106	2457	2808
30x16	2.015 ft ²	423	CFM	540	806	1209	1612	2015	2418	2821	3224
30x18	2.275 ft ²	477	CFM	610	910	1365	1820	2275	2730	3185	3640
30x20	2.535 ft ²	532	CFM	679	1014	1521	2028	2535	3042	3549	4056
30x24	3.055 ft ²	641	CFM	819	1222	1833	2444	3055	3666	4277	4888
30x30	3.835 ft ²	804	CFM	1028	1534	2301	3068	3835	4602	5369	6136
36x6	0.858 ft ²	804	CFM	230	343.2	514.8	686.4	858	1029.6	1201.2	1372.8
36x8	1.17 ft ²	245	CFM	314	468	702	936	1170	1404	1638	1872
36x10	1.482 ft ²	311	CFM	397	592.8	889.2	1185.6	1482	1778.4	2074.8	2371.2
36x12	1.794 ft ²	376	CFM	481	717.6	1076.4	1435.2	1794	2152.8	2511.6	2870.4
36x14	2.106 ft ²	442	CFM	564	842.4	1263.6	1684.8	2106	2527.2	2948.4	3369.6
36x16	2.418 ft ²	507	CFM	648	967.2	1450.8	1934.4	2418	2901.6	3385.2	3868.8
36x18	2.73 ft ²	572	CFM	732	1092	1638	2184	2730	3276	3822	4368
36x20	3.042 ft ²	638	CFM	815	1216.8	1825.2	2433.6	3042	3650.4	4258.8	4867.2
36x24	3.666 ft ²	769	CFM	982	1466.4	2199.6	2932.8	3666	4399.2	5132.4	5865.6
36x30	4.602 ft ²	965	CFM	1233	1840.8	2761.2	3681.6	4602	5522.4	6442.8	7363.2
36x36	5.538 ft ²	1161	CFM	1484	2215.2	3322.8	4430.4	5538	6645.6	7753.2	8860.8

950 or 951 Series

Please refer to Footnote A & C below.

SIZE Eff.Area	Velocity Duct Pt	400 .011	500 .017	600 .024	700 .034	800 .044	1000 .055	1200 .068	1400 .100
8x4 .155 ft ²	CFM	67	90	106	123	140	168	207	246
	Throw	5.5/6/6.5	7/8/9	8.5/10/11.5	10/12/14	11/13/15	13.5/17/20	16/20/24	19/24/29
	NC	20	25	30	30	30	35	35	40
10x4 .198 ft ²	CFM	90	112	134	157	179	224	269	314
	Throw	7/8/9	9/10/11	10/12/14	11/13/15	13.5/16/18	15/19/23	19/24/29	22/27/32
	NC	20	25	30	30	30	35	35	40
12x4 .241 ft ²	CFM	106	134	162	190	213	269	325	375
	Throw	7/8/9	9/10/11	10/12/14	13/15/17	14.5/17/20	14.5/18/22	18/22/26	23/29/35
	NC	20	25	30	30	30	35	35	40
14x4 .280 ft ²	CFM	129	157	190	218	252	314	381	443
	Throw	8/9/10	10/11/12	11/13/15	13.5/16/18	15.5/18/21	15/19/23	19/24/29	25/31/37
	NC	20	25	30	30	30	35	35	40
10x6 .313 ft ²	CFM	140	174	213	246	280	353	420	493
	Throw	8/9/10	11/12/13	13/15/17	14.5/17/20	17/20/23	20/25/30	24/30/36	28/35/42
	NC	20	25	30	30	30	35	35	40
12x6 .380 ft ²	CFM	168	213	213	297	342	426	510	594
	Throw	9/10/11	11.5/13/14.5	13.5/16/18	15.5/18/21	17/21/24	22/27/32	26/32/38	30/38/46
	NC	20	25	30	30	30	35	35	40
14x6 .446 ft ²	CFM	202	252	302	347	398	498	599	700
	Throw	10/11/12	13.5/15/17	15.5/18/21	17/20/23	20/24/28	24/30/36	28/35/42	34/43/52
	NC	20	25	30	30	30	35	35	40
16x6 .510 ft ²	CFM	230	286	342	403	459	571	689	801
	Throw	10/11/12	13.5/15/17	15.5/18/21	17/21/24	20/24/28	24/30/36	30/37/44	34/43/52
	NC	20	25	30	35	35	35	35	40
20x6 .645 ft ²	CFM	291	364	431	504	577	722	868	1014
	Throw	11.5/13/14.5	16/18/20	18/21/24	20/24/28	24/28/32	26/32/38	32/40/48	36/45/54
	NC	20	25	30	35	35	35	35	40
14x8 .590 ft ²	CFM	269	330	398	465	526	661	795	924
	Throw	11/12/13	14.5/16/18	16/19/22	19/22/25	22/26/30	25/31/37	30/38/46	35/44/53
	NC	20	25	30	35	35	40	40	40
16x8 .660 ft ²	CFM	297	370	448	515	588	739	885	1036
	Throw	13.5/15/17	17/19/21	19/22/25	22/26/30	25/30/35	30/37/45	34/43/52	38/47/56
	NC	20	25	30	35	35	40	40	45
20x8 .880 ft ²	CFM	398	493	594	689	790	986	1187	1383
	Throw	15.5/17/19	18/20/22	20/24/28	23/28/32	27/32/37	32/40/48	37/46/55	42/52/62
	NC	20	25	30	35	35	40	40	45
20x12 1.620 ft ²	CFM	517	644	770	902	1028	1288	1546	1805
	Throw	18/20/23	23/25/27	25/30/34	30/36/41	34/40/46	40/50/60	48/60/71	56/70/84
	NC	20	25	30	35	35-40	40	40-45	45-50

955 Series

Please refer to Footnote A & C below.

SIZE Eff.Area	Velocity Duct Pt	400 .011	500 .017	600 .024	700 .034	800 .044	1000 .055	1200 .068	1400 .100
8x6 .241 ft ²	CFM	106	134	162	190	213	269	325	375
	Throw	7/8/9	9/10/11	10/12/14	13/15/17	15/17/20	14/18/22	18/22/26	23/29/35
	NC	20	25	30	30	30	35	35	40
10x6 .313 ft ²	CFM	140	174	213	246	280	353	420	493
	Throw	8/9/10	11/12/13	13/15/17	15/17/20	17/20/23	20/25/30	24/30/36	28/35/42
	NC	20	25	30	30	30	35	35	40
12x6 .380 ft ²	CFM	168	213	213	297	342	426	510	594
	Throw	9/10/11	12/13/14	14/16/18	15/18/21	17/21/24	22/27/32	26/32/38	30/38/46
	NC	20	25	30	30	30	35	35	40
14x6 .446 ft ²	CFM	202	252	302	347	398	498	599	700
	Throw	10/11/12	14/15/17	15/18/21	17/20/23	20/24/28	24/30/36	28/35/42	34/43/52
	NC	20	25	30	30	30	35	35	40
12x8 .510 ft ²	CFM	230	286	342	403	459	571	689	801
	Throw	10/11/12	14/15/17	15/18/21	17/21/24	20/24/28	24/30/36	30/37/44	34/43/52
	NC	20	25	30	35	35	35	35	40
14x8 .590 ft ²	CFM	269	330	398	465	526	661	795	924
	Throw	11/12/13	14/16/18	16/19/22	19/22/25	22/26/30	25/31/37	30/38/46	35/44/53
	NC	20	25	30	35	35	40	40	40
14x10 .770 ft ²	CFM	347	430	521	602	689	862	1036	1229
	Throw	15/16/18	18/20/22	20/23/27	23/27/31	26/31/36	31/39/46	36/45/54	40/50/59
	NC	20	25	30	35	35	40	40	45

FOOTNOTE A: **SIZE:** Nominal size or the duct opening. **EFFECTIVE AREA:** The space between the vanes actually utilized by the air. **VELOCITY:** The actual velocity of the air through the vanes measured with a velometer or similar device. **DUCT Pt:** The total pressure behind the register in the duct forcing that air through the register. **THROW:** The throws noted in the tables are the distance from the register to where the air stream velocity has dropped to not under 75 F.P.M.

FOOTNOTE B: **SIZE:** Nominal size or the duct opening. **EFFECTIVE AREA:** The space between the vanes actually utilized by the air. **VELOCITY:** The actual velocity of the air through the vanes measured with a velometer or similar device. **DUCT Ps:** The static pressure in the duct behind the grille. The static load on the fan chargeable against that grille. Velometer readings are taken between grille vanes giving actual velocity.

FOOTNOTE C: NOISE CRITERIA: NC "A" scale. (1) Below NC25 extremely quiet. (2) Below NC30 Quiet Office. (3) Below NC35 Conference Rooms; normal voice 10-30 ft. (4) Below NC40 Conference Rooms; 6-12 ft. normal voice. (5) NC45 conference Rooms; 3-6 ft. normal voice.

1550 Series

Please refer to Footnote A below.

SIZE	Velocity	400	500	600	700	800	1000
Eff.Area	Duct Pt	.011	.017	.024	.034	.044	.068
4x10 .25 ft ²	CFM	76	95	114	133	152	190
	Throw	9/10/11	11/12/13	13/15/17	15.5/18/21	17/21/25	20/25/30
	NC	20	25	30	30	35	35
4x12 .29 ft ²	CFM	95	119	143	166	190	238
	Throw	10/11/12	12.5/14/15.5	14.5/17/20	17/20/23	19/24/29	24/30/36
	NC	20	25	30	30	35	35
4x14 .34 ft ²	CFM	105	133	162	185	214	266
	Throw	9/10/11	12.5/14/15.5	15.5/18/21	18/21/24	19/24/29	24/30/37
	NC	20	25	30	30	35	35
6x8 .29 ft ²	CFM	95	119	143	166	190	238
	Throw	10/11/12	12.5/14/15.5	14.5/17/20	17/20/23	19/24/29	24/30/36
	NC	20	25	30	30	35	35
6x10 .38 ft ²	CFM	124	152	181	214	242	337
	Throw	11.5/13/14.5	14.5/16/18	17/20/23	20/23/27	21/26/31	26/32/38
	NC	20	25	30	30	35	35
6x12 .44 ft ²	CFM	143	180	219	252	290	361
	Throw	12.5/14/15.5	16/18/20	19/22/25	21/25/29	22/28/34	29/36/43
	NC	20	25	30	30	35	35
6x14 .51 ft ²	CFM	166	209	252	295	333	418
	Throw	13.5/15/17	17/19/21	21/23/27	23/27/31	22/27/32	31/42/50
	NC	20	25	30	30	35	35
6x16 .59 ft ²	CFM	185	233	280	328	371	466
	Throw	13.5/15/17	18/20/22	20/24/28	25/29/33	26/33/40	34/42/50
	NC	20	25	30	30-35	35-40	40
8x8 .40 ft ²	CFM	124	152	181	214	242	337
	Throw	12/13/14.5	14.5/16/18	17/20/23	20/23/27	21/26/31	26/32/38
	NC	20	25	30	30-35	35	35-40
8x10 .50 ft ²	CFM	201	200	238	280	318	399
	Throw	13/14/15.5	15.5/17/19	20/23/27	23/27/31	24/30/36	31/39/47
	NC	20	25	30-35	30-35	35-40	40
8x12 .58 ft ²	CFM	200	252	304	352	404	504
	Throw	14.5/16/18	18/20/22	21/25/29	26/30/35	28/35/42	37/46/55
	NC	20	25	30-35	30-35	35-40	40
8x14 .69 ft ²	CFM	228	285	342	399	456	570
	Throw	17/19/21	21/23/25	24/28/32	27/32/37	30/37/44	39/48/58
	NC	20	25	30-35	30-35	35-40	40
8x16 .80 ft ²	CFM	261	328	394	461	523	656
	Throw	18/20/22	23/26/29	26/30/35	30/35/40	32/40/48	40/50/60
	NC	20	25	30-35	30-35	35-40	40
10x10 .63 ft ²	CFM	200	252	304	352	404	504
	Throw	14.5/16/18	18/20/22	21/25/29	26/30/35	28/35/42	37/46/55
	NC	20	25	30-35	30-35	35-40	40
10x12 .75 ft ²	CFM	247	309	371	432	494	618
	Throw	15/17/19	21/23/25	25/29/33	28/33/38	31/39/47	38/48/58
	NC	20	25	30-35	30-35	35-40	40
10x14 .87 ft ²	CFM	295	371	447	518	594	741
	Throw	18/20/22	24/27/30	27/32/37	32/38/44	35/44/53	42/53/64
	NC	20	25	30-35	30-35	35-40	40
10x16 .99 ft ²	CFM	333	418	504	584	670	836
	Throw	20/22/24	26/29/32	27/32/37	33/39/45	37/46/55	46/57/68
	NC	20	25	30-35	35	40	45
12x12 .85 ft ²	CFM	295	371	447	518	594	741
	Throw	18/20/22	24/27/30	27/32/37	32/38/44	35/44/53	42/53/64
	NC	20	25	30-35	30-35	35-40	40-45
12x14 1.1 ft ²	CFM	352	442	532	618	708	884
	Throw	21/23/25	26/29/32	30/35/40	35/41/47	38/48/58	47/59/71
	NC	20	25	30-35	35	40	45
12x16 1.2 ft ²	CFM	409	508	608	713	812	1017
	Throw	23/25/28	27/30/33	32/37/43	37/44/51	40/50/60	49/61/73
	NC	20	25	30-35	35	40	45
12x18 1.4 ft ²	CFM	466	580	694	812	926	1159
	Throw	24/27/30	29/32/35	34/40/46	40/47/54	42/53/64	52/65/78
	NC	20	25	30-35	35	40	45
12x24 1.8 ft ²	CFM	603	755	907	1059	1207	1511
	Throw	26/29/32	33/37/41	37/44/51	42/49/56	45/56/67	54/67/80
	NC	20	25	35	35	40	45
14x14 1.2 ft ²	CFM	409	508	608	713	812	1017
	Throw	23/25/28	27/30/33	32/37/43	37/44/51	40/50/60	49/61/73
	NC	20	25	35	35	40	45
14x16 1.4 ft ²	CFM	466	580	30-694	812	926	1159
	Throw	24/27/30	29/32/35	34/40/46	40/47/54	42/53/64	52/65/78
	NC	20	25	35	35	40	45
14x18 1.6 ft ²	CFM	541	675	808	945	1078	1349
	Throw	26/29/32	32/35/39	37/43/50	42/49/56	44/55/66	52/65/78
	NC	20	25	35	35	40	45
14x20 1.8 ft ²	CFM	603	755	907	1059	1207	1511
	Throw	26/29/32	33/37/41	37/44/51	42/49/56	45/56/67	54/67/80
	NC	20	25	35	35	40	45
16x16 1.6 ft ²	CFM	544	675	808	945	1078	1349
	Throw	26/29/32	32/35/39	37/43/50	42/49/56	44/55/66	52/65/78
	NC	20	25	35	35	40	45

FOOTNOTE A: SIZE: Nominal size or the duct opening. **EFFECTIVE AREA:** The space between the vanes actually utilized by the air. **VELOCITY:** The actual velocity of the air through the vanes measured with a velometer or similar device. **DUCT Pt:** The total pressure behind the register in the duct forcing that air through the register. **THROW:** The throws noted in the tables are the distance from the register to where the air stream velocity has dropped to not under 100/75/50 F.P.M.

FG

Refer to footnote below

		Free	Velocity	300	400	600	800	1000	1200	1400	1600
Size	Eff Area	Area	Duct Pt	0.007	0.01	0.023	0.04	0.064	0.09	0.123	0.16
10x10	0.38 ft2	.75 ft2	CFM	101	152	228	304	380	456	532	608
12x12	0.598 ft2	1.13 ft2	CFM	160	239.2	358.8	478.4	598	717.6	837.2	956.8
14x14	0.81 ft2	1.54 ft2	CFM	216	324	486	648	810	972	1134	1296
16x16	0.992 ft2	1.94 ft2	CFM	265	396.8	595.2	793.6	992	1190.4	1388.8	1587.2
18x18	1.365 ft2	2.58 ft2	CFM	364	546	819	1092	1365	1638	1911	2184
20x12	0.92 ft2	1.99 ft2	CFM	245	368	552	736	920	1104	1288	1472
20x14	1.08 ft2	2.33 ft2	CFM	288	432	648	864	1080	1296	1512	1728
20x16	1.24 ft2	2.68 ft2	CFM	331	496	744	992	1240	1488	1736	1984
20x20	1.56 ft2	3.37 ft2	CFM	416	624	936	1248	1560	1872	2184	2496
24x12	1.196 ft2	2.51 ft2	CFM	319	478.4	717.6	956.8	1196	1435.2	1674.4	1913.6
24x14	1.404 ft2	2.94 ft2	CFM	375	561.6	842.4	1123.2	1404	1684.8	1965.6	2246.4
24x16	1.612 ft2	3.38 ft2	CFM	430	644.8	967.2	1289.6	1612	1934.4	2256.8	2579.2
24x20	2.028 ft2	4.25 ft2	CFM	541	811.2	1216.8	1622.4	2028	2433.6	2839.2	3244.8
25X12	1.29 ft2	2.60 ft2	CFM	329	492.8	739.1	985.5	1231.9	1478.3	1724.6	1971.0
25X14	1.53 ft2	3.06 ft2	CFM	386	578.4	867.7	1156.9	1446.1	1735.3	2024.6	2313.8
25X16	1.80 ft2	3.51 ft2	CFM	443	664.1	996.2	1328.3	1660.4	1992.4	2324.5	2656.6
25X20	2.14 ft2	4.40 ft2	CFM	557	835.5	1253.3	1671.1	2088.8	2506.6	2924.4	3342.1
30x12	1.495 ft2	3.14 ft2	CFM	399	598	897	1196	1495	1794	2093	2392
30x14	1.755 ft2	3.68 ft2	CFM	468	702	1053	1404	1755	2106	2457	2808
30x16	2.015 ft2	4.23 ft2	CFM	538	806	1209	1612	2015	2418	2821	3224
30x20	2.535 ft2	5.32 ft2	CFM	676	1014	1521	2028	2535	3042	3549	4056
36x20	3.042 ft2	6.38 ft2	CFM	812	1216.8	1825.2	2433.6	3042	3650.4	4258.8	4867.2
40X20	3.51 ft2	7.10 ft2	CFM	874	1310.4	1965.6	2620.8	3276	3931.2	4586.4	5241.6

920FG

Refer to footnote below

		Velocity	300	400	500	600	700	800	900
Size	Eff Area	Duct Pt	0.007	0.01	0.023	0.04	0.064	0.09	0.123
10x10	0.784 ft2	CFM	272	309	366	453	515	608	690
12x12	0.986 ft2	CFM	331	381	484	577	670	762	865
14x14	1.27 ft2	CFM	415	494	618	742	865	989	1112
16x16	1.57 ft2	CFM	486	608	762	917	1071	1215	1370
18x18	2.07 ft2	CFM	642	803	1009	1205	1411	1607	1803
20x12	1.85 ft2	CFM	482	602	757	904	1058	1205	1352
20x14	2.16 ft2	CFM	566	707	888	1060	1242	1414	1587
20x16	2.07 ft2	CFM	642	803	1009	1205	1411	1607	1803
20x20	3.02 ft2	CFM	791	989	1246	1494	1741	1998	2224
24x12	2.22 ft2	CFM	570	712	897	1076	1254	1439	1601
24x14	2.59 ft2	CFM	665	831	1047	1255	1462	1678	1868
24x16	2.96 ft2	CFM	759	949	1196	1434	1671	1918	2135
24x20	3.7 ft2	CFM	919	1149	1442	1724	2016	2298	2591
25X12	2.21 ft2	CFM	594	742	935	1121	1306	1499	1668
25X14	2.42 ft2	CFM	692	865	1090	1307	1523	1748	1946
25X16	2.57 ft2	CFM	791	989	1246	1494	1741	1998	2224
25X20	2.99 ft2	CFM	958	1197	1502	1796	2100	2394	2699
30x12	2.52 ft2	CFM	705	881	1105	1321	1545	1761	1985
30x14	2.75 ft2	CFM	822	1027	1289	1541	1803	2055	2316
30x16	3.02 ft2	CFM	939	1174	1473	1761	2060	2348	2647
30x20	3.70 ft2	CFM	1168	1460	1830	2190	2560	2920	3290
36x20	5.04 ft2	CFM	1402	1752	2196	2628	3072	3504	3948
40X20	5.6 ft2	CFM	1577	1971	2471	2957	3456	3942	4442

FOOTNOTE:

- 1) Tested without filters. Typical disposable 1" capacity is 2 cfm per square inch of gross filter area. Recommended velocity is 300-400fpm. Velocities higher than 500 fpm will decrease filter performance. Increase flow resistance, and possibly blow off agglomerates of collected dirt. Velocity measured 1" from face.
- 2) Generally the more surface area of media you have in an air filter the lower pressure drop you will have across the filter.
- 3) Lower face velocities (the air speed at the face of the filter) will also produce less pressure drop across the filter while higher return air velocity ties cause higher pressure drop and can cause the filter to blow off agglomerates. Ashrae calls out for 300 FPM face velocity across the filter face. This is the ideal return air velocity. Actual face velocities will vary depending on the system design."

Example: 20x25 filter = 3.47 SF x 300 FPM face velocity = 1041 CFM
 20x25 filter = 3.47 SF x 500 FPM face velocity = 1736 CFM

1600 Series

Please refer to Footnote B below.

	Eff.	Velocity	400	500	600	700	800	1000	1200	1400
SIZE	Area	Duct Ps	.011	.017	.023	.031	.040	.062	.089	.12
4x10	.25	CFM	121	155	184	213	259	311	380	454
4x12	.290	CFM	138	173	201	230	276	334	403	483
4x14	.340	CFM	155	196	230	270	340	385	454	529
6x10	.375	CFM	173	213	253	299	339	426	512	592
6x12	.440	CFM	207	259	305	357	408	512	610	713
6x14	.51	CFM	230	288	345	403	460	575	690	805
8x12	.58	CFM	270	339	403	477	541	673	794	920
8x14	.685	CFM	311	403	472	546	633	782	932	1081
12x12	.85	CFM	391	489	587	684	782	978	1173	1369
6x24	.85	CFM	391	489	587	684	782	978	1173	1369
6x30	1.05	CFM	472	592	713	828	949	1185	1420	1656
8x24	1.10	CFM	512	638	765	891	1024	1277	1530	1783
8x30	1.35	CFM	621	782	943	1093	1254	1553	1857	2128
14x14	1.15	CFM	529	661	805	920	1064	1323	1581	1834
14x20	1.55	CFM	725	909	1093	1271	1455	1823	2191	2473
10x30	1.66	CFM	771	966	1167	1380	1553	1926	2300	2674
18x18	1.80	CFM	828	1035	1242	1466	1656	2070	2484	2904
14x24	1.88	CFM	863	1064	1294	1512	1725	2156	2588	3019
14x30	2.35	CFM	1081	1351	1622	1892	2162	2703	3243	3784
24x24	3.1	CFM	1426	1783	2156	2501	2852	3565	4278	4991

FOOTNOTE B:

SIZE: Nominal size or the duct opening.

EFFECTIVE AREA: The space between the vanes actually utilized by the air.

VELOCITY: The actual velocity of the air through the vanes measured with a velometer or similar device.

DUCT Ps: The static pressure in the duct behind the grille. The static load on the fan chargeable against that grille. Velometer readings are taken between grille vanes giving actual velocity.

875 Series

Please refer to footnote C below.

Size	Velocity	400	600	800	1000	1200	1400	1600
Effective Area	Duct Pt	0.01	0.023	0.04	0.064	0.09	0.123	0.16
15 inch 875 0.164	CFM	65.6	98.4	131.2	164.0	196.8	229.6	262.4
	Throw	4	4.5	5	6	6.5	7	8
	Spread	3.5	4	4.5	5.5	6	6.5	7.5
18 inch 875 0.192	CFM	76.8	115.2	153.6	192.0	230.4	268.8	307.2
	Throw	5	6	7	8	9	10	11
	Spread	4.5	5.5	6.5	7.5	8.5	9.5	10.5
24 inch 875 0.275	CFM	110.0	165.0	220.0	275.0	330.0	385.0	440.0
	Throw	6	7.5	8.5	9.5	11	12	13
	Spread	5.5	6.75	7.75	8.75	10	11	12

FOOTNOTE C: Duct Pt: The total pressure behind the register in the duct forcing that air through the register.

Effective Area: The space between the vanes actually utilized by the air. **Velocity:** the actual velocity of the air through the vanes measured with a velometer or similar device. **Throw:** Is the vertical distance of the air pattern in feet. Throw and spread measurements based on a terminal velocity of 50 F.P.M. **Spread:** The horizontal distance of the air pattern in feet.

SCB41 Series (4-way)

Please refer to Footnote below.

SIZE Eff.Area	Velocity Duct Pt	400 .038	500 .108	600 .155	700 .220	800 .285	1000 .438
6x6 .09 ft ²	Total CFM	77	99	121	143	154	286
	CFM x/y	13/26	19/29	24/36	28/42	30/46	39/59
	Throw x	2.5/3/3.5	2.5/3/3.5	3/4/5	3/4/5	3/4/5	5/6/7
	Throw y	3/4/5	5/6/7	5/6/7	6.5/8/9.5	6.5/8/9.5	8.5/11/13
	NC	<20	<20	<20	<20	20	20
8x8 .17 ft ²	Total CFM	143	176	209	242	286	352
	CFM x/y	28/42	35/52	41/62	48/72	57/85	70/105
	Throw x	3/4/5	3/4/5	5/6/7	5/6/7	6.5/8/9.5	8.5/11/13
	Throw y	3/4/5	3/4/5	5/6/7	5/6/7	6.5/8/9.5	8.5/11/13
	NC	<20	<20	<20	<20	20	25
10x10 .26 ft ²	Total CFM	247	312	377	442	494	624
	CFM x/y	49/74	62/93	75/113	88/132	98/148	124/187
	Throw x	3/4/5	5/6/7	6.5/8/9.5	6.5/8/9.5	6.5/8/9.5	9.5/12/14.5
	Throw y	3/4/5	5/6/7	6.5/8/9.5	8.5/11/13	10.5/13/15.5	12/15/18
	NC	<20	<20	20	20-25	25	25-30
12x12 .38 ft ²	Total CFM	377	442	546	637	728	910
	CFM x/y	75/113	88/132	109/163	127/191	145/218	182/273
	Throw x	3/4/5	5/6/7	6.5/8/9.5	6.5/8/9.5	8.5/11/13	12/15/18
	Throw y	6.5/8/9.5	6.5/8/9.5	10.5/13/15.5	10.5/13/15.5	13.5/17/20.5	20.5/26/31
	NC	<20	<20	20	20-25	25	25-30
14x14 .52 ft ²	Total CFM	494	624	754	871	1001	1248
	CFM x/y	98/148	124/187	150/226	174/261	200/300	249/374
	Throw x	3/4/5	5/6/7	6.5/8/9.5	6.5/8/9.5	8.5/11/13	12/15/18
	Throw y	6.5/8/9.5	9.5/12/14.5	12/15/18	13.5/17/20.5	15/19/23	20.5/26/31
	NC	<20	<20	20	25	25-30	30

SCB31 Series (3-way)

Please refer to Footnote below.

SIZE Eff.Area	Velocity Duct Pt	400 .038	500 .108	600 .155	700 .220	800 .285	1000 .438
6x6 .09 ft ²	Total CFM	77	99	121	143	154	286
	CFM x/y	19/28	24/37	33/44	24/52	39/57	52/72
	Throw x	4/4/4	4/4/4	3/4/5	5/6/7	6/8/10	6/8/10
	Throw y	4/4/4	5/6/7	5/6/7	5/6/7	6/8/10	9/11/13
	NC	<20	<20	<20	<20	20	20
8x8 .17 ft ²	Total CFM	143	176	209	242	286	352
	CFM x/y	24/52	52/61	63/72	66/88	74/105	105/123
	Throw x	5/6/7	5/6/7	5/6/7	5/6/7	6/8/10	9/11/13
	Throw y	4/4/4	4/4/4	5/6/7	5/6/7	6/8/10	9/11/13
	NC	<20	<20	<20	<20	20	25
10x10 .26 ft ²	Total CFM	247	312	377	442	494	624
	CFM x/y	75/85	93/109	111/132	130/156	150/171	187/218
	Throw x	4/4/4	5/6/7	5/6/7	7/8/9	9/11/13	10/13/16
	Throw y	5/6/7	7/8/9	9/11/13	11/13/15	10/13/16	12/15/18
	NC	<20	<20	20	20-25	25	25-30
12x12 .38 ft ²	Total CFM	377	422	546	637	754	910
	CFM x/y	111/132	130/156	166/189	195/221	223/265	286/312
	Throw x	4/4/4	5/6/7	5/6/7	7/8/9	9/11/13	10/13/16
	Throw y	7/8/9	7/8/9	11/13/15	13/15/17	14/17/20	15/19/23
	NC	<20	<20	20	20-25	25	25-30
14x14 .52 ft ²	Total CFM	494	624	754	871	1001	1248
	CFM x/y	150/171	187/218	223/265	257/306	299/351	364/442
	Throw x	5/6/7	5/6/7	7/8/9	7/8/9	9/11/13	12/15/18
	Throw y	7/8/9	10/13/16	13/15/17	15/17/20	15/19/23	21/26/31
	NC	<20	<20	20	25	25-30	30

ENGINEERING FOOTNOTE FOR SCB SERIES:
SIZE: Nominal size or the duct opening. **EFFECTIVE AREA:** The space between the vanes actually utilized by the air.

VELOCITY: The actual velocity of the air through the vanes measured with a velometer or similar device.

DUCT Pt: The total pressure behind the register in the duct forcing that air through the register. **THROW:** The throws noted in the tables are the distance from the register to where the air stream velocity has dropped to not under 100/75/50 F.P.M.

NOISE CRITERIA: NC "A" scale. (1) Below NC25 extremely quiet. (2) Below NC30 Quiet Office. (3) Below NC35 Conference Rooms; normal voice 10-30 ft. (4) Below NC40 Conference Rooms; 6-12 ft. normal voice. (5) NC45 Conference Rooms; 3-6 ft. normal voice.

Wood Oak 350 Series

Please refer to Footnote A & C below.

SIZE Eff.Area	Velocity Duct Pt	300 .007	400 .011	500 .017	600 .024	700 .034	800 .044	900 .055	1000 .068
21/4 x10 .086 ft ²	CFM	10.5	14	17.5	22	24.5	28	31.5	34.5
	Throw	1/1/1	1/1.5/2	1.5/1.5/2	1.5/2/2	2/2.5/2.5	2/2.5/3	2.5/3/3.5	2.5/3.5/4
	Spread	2	2.5	3	3.5	4	4.5	5	6
	NC	<20	20	25	25	30	35	35	40
21/4 x12 .099 ft ²	CFM	13	17	22	26	30.5	35	39	43
	Throw	1/1.5/2	1.5/1.5/2	2/2/2.5	2.5/2.5/3	2.5/2.5/3	2.5/3/3.5	2.5/3/4	2.5/3.5/4
	Spread	2	3	3.5	4	4.5	5	5.5	6
	NC	<20	20	25	25	30	35	35	40
21/4 x14 .115 ft ²	CFM	15	20	25	30	34.5	40	45	49.5
	Throw	1/1.5/1.5	1.5/2/2	2/2/2.5	2.5/2.5/3	2.5/3/3.5	3/3.5/4	3.5/4/4.5	3.5/4/5
	Spread	2	3	3.5	4	5	5.5	6	6.5
	NC	<20	20	25	25	30	35	35	40
4x10 .166 ft ²	CFM	22	29	37	44	51	59	66	73
	Throw	2/2/2	2.5/3/3.5	3/3.5/4	3.5/4/4.5	4.5/5/6	4.5/5.5/6.5	5/6/7	5.5/7/8.5
	Spread	2.5	3	4	5	5.5	6	7	8
	NC	<20	20	25	25	30	35	35	40
4x12 .194 ft ²	CFM	27	36	46	55	64	73	82	91
	Throw	2/2.5/3	2.5/3/3.5	3.5/4/4.5	4.5/5/6	4.5/5.5/6.5	5/6/7	5/6.5/8	5.5/7/8.5
	Spread	3	3.5	4.5	5.5	6	7	7.5	8
	NC	<20	20	25	25	30	35	35	40
4x14 .222 ft ²	CFM	31	42	53	63	73	84	94	104
	Throw	2/2.5/3	3/3.5/4	3.5/4/4.5	4.5/5/6	5/6/7	6/7/8	6.5/8/9.5	7/8.5/10
	Spread	3	4	5	5.5	6.5	7.5	8	9
	NC	<20	20	25	25	30	35	35	40
6x10 .238 ft ²	CFM	47	62	78	93	109	124	140	154
	Throw	3.5/4/4.5	5/5.5/6	6.5/7/7.5	7/8/9	8.5/10/11.5	9.5/11/12.5	10/12.5/15	11/14/17
	Spread	3	4	5	6	7	8	10	11
	NC	<20	20	25	30	35	40	40	40
6x12 .275 ft ²	CFM	58	77	97	115	132	152	171	191
	Throw	4.5/5/5.5	5.5/6/6.5	7/8/9	7.5/9/10.5	9.5/11/12.5	11/13/15	11.5/14.5/17	12.5/15.5/19
	Spread	3.5	5	6	7	8	9	10	12
	NC	<20	20	25	25	30	35	40	40
6x14 .358 ft ²	CFM	63	84	106	127	147	169	190	210
	Throw	4.5/5/5.5	6/6.5/7	7/8/9	8.5/10/11.5	10/11.5/13	11/13/15	11.5/14.5/17	13/16/19
	Spread	4	5	6	7	9	10	11	12
	NC	<20	20	25	25	30	35	40	40

FOOTNOTE A:

SIZE: Nominal size or the duct opening.

EFFECTIVE AREA: The space between the vanes actually utilized by the air.

VELOCITY: The actual velocity of the air through the vanes measured with a velometer or similar device.

DUCT Pt: The total pressure behind the register in the duct forcing that air through the register.

THROW: The throws noted in the tables are the distance from the register to where the air stream velocity has dropped to not under 100/75/50 F.P.M.

FOOTNOTE C:

NOISE CRITERIA: NC "A" scale.

- (1) Below NC25 extremely quiet.
- (2) Below NC30 Quiet Office.
- (3) Below NC35 Conference Rooms; normal voice 10-30 ft.
- (4) Below NC40 Conference Rooms; 6-12 ft. normal voice.
- (5) NC45 Conference Rooms; 3-6 ft. normal voice.

Engineering Data for SERIES Linear 1/3" Return Air Grilles

SIZE	Effective	Velocity	300	400	500	600	700	800	900	1000
Width In.	Area	Duct Ps	.006	.032	.048	.070	.092	.120	.130	.140
1 1/2	.121 ft ²	CFM/ft	36	48	61	73	85	97	108	120
2	.153 ft ²	CFM/ft	46	61	77	92	107	122	138	153
2 1/2	.189 ft ²	CFM/ft	57	76	95	113	132	151	170	189
3	.225 ft ²	CFM/ft	68	90	112	135	158	180	203	225
3 1/2	.252 ft ²	CFM/ft	76	100	126	151	176	202	227	252
4	.279 ft ²	CFM/ft	84	112	140	166	195	222	250	279
5	.342 ft ²	CFM/ft	103	137	171	205	240	275	305	342
6	.396 ft ²	CFM/ft	119	158	198	240	275	315	355	396
8	.486 ft ²	CFM/ft	146	195	245	290	340	388	440	486
10	.585 ft ²	CFM/ft	175	235	290	350	410	470	525	585
12	.666 ft ²	CFM/ft	200	265	330	440	465	530	600	666
14	.741 ft ²	CFM/ft	220	300	370	445	520	590	665	741

Note: All values in above table are per lineal foot.

Engineering Data for SERIES Linear 1/3" Supply Diffuser

SIZE/width Eff.Area	Velocity Duct Pt	300 .006	400 .010	500 .015	600 .021	700 .029	800 .038	900 .048	1000 .065
1 1/2 .047 ft ²	CFM/ft Throw NC	14 2/2.5/3 <20	19 3/3.5/4 <20	24 4.5/5/5.5 <20	28 4.5/5.5/6.5 20	33 6/7/8 25	38 7/8/9 25-30	42 7.5/9.5/11.5 30-35	47 9/11/13 35
2 .079 ft ²	CFM/ft Throw NC	24 4.4/5/5 <20	32 4.5/5/5.5 <20	40 7/7.5/8.5 <20	47 7/8/9 20	55 8/9.5/11 25	63 10/11.5/13 25-30	71 9.5/12/14.5 30-35	79 11/14/17 35
2 1/2 .100 ft ²	CFM/ft Throw NC	30 4.5/5/5.5 <20	40 5.5/6/6.5 <20	50 7/8/9 20	60 8/9.5/11 20	70 9.5/11/12.5 25	80 10/12/14 25-30	90 11/14/17 30-35	100 12.5/15.5/19 35
3 .131 ft ²	CFM/ft Throw NC	39 5/5.5/6 <20	52 6.3/7/7.5 <20	66 8.5/9.5/10.5 20	79 9.4/11/12.5 20	92 10/12/14 25	105 12/14/16 25-30	118 12.5/15.5/19 30-35	131 14.5/18/22 35
3 1/2 .158 ft ²	CFM/ft Throw NC	47 5/5.6/6 <20	63 7/8/9 <20	79 8.5/9.5/10/5 20	95 9.5/11/12.5 20	111 10/12/14 25	126 12/14/16 30	142 12.5/15.5/19 35	158 14.5/18/22 35-40
4 .289 ft ²	CFM/ft Throw NC	57 5.5/6/6.5 <20	76 7/8/9 <20	95 10/11/12 20	113 11.5/13.5/16 25	132 13/15.5/18 25	151 15.5/18/21 30	170 16/20/24 35	189 17/22/26 40
5 .247 ft ²	CFM/ft Throw NC	74 7/7.5/8.5 <20	99 8/9/10 <20	124 11/12/13 20	148 13/15/17 20	173 14/17/19 25	198 16/19/21 30	222 17/21/25 30-35	247 18/23/28 40
6 .300 ft ²	CFM/ft Throw NC	90 7/8/9 <20	120 10/11/12 <20	150 12.5/14/15.5 20	180 13/16/18 25	210 15.5/18/21 25-30	240 17/20/23 30	270 18/23/27 35-40	300 20/26/31 40
8 .410 ft ²	CFM/ft Throw NC	123 8/9/10 <20	164 11/12.5/14 <20	205 14/15.5/17 20	246 15/18/21 25	287 17/20/23 30	328 19/23/26 30-35	369 20/26/31 35-40	410 24/30/36 40
10 .525 ft ²	CFM/ft Throw NC	158 11/12/13 <20	210 12/13.5/15 20	315 16/18/20 25	368 17/20/23 25-30	420 19/23/26 30	473 22/26/29 30-35	525 24/30/36 40	577 29/36/43 40
12 .630 ft ²	CFM/ft Throw NC	189 11.5/12.5/14 <20	252 12.5/14/15.5 20	315 18/20/22 25	378 20/23/27 30	441 23/27/31 35	504 27/32/36 40	567 29/36/43 40	630 31/39/47 45
14 .745 ft ²	CFM/ft Throw NC	224 12/13.5/15 <20	298 13.5/15/17 20	373 19/22/24 25	447 22/26/29 30	522 27/32/36 35-40	596 29/35/40 40	670 30/38/45 45	745 34/42/50 45

Note: All values in above table are per lineal foot.

FOOTNOTE: SIZE: Nominal size or the duct opening.

EFFECTIVE AREA: The space between the vanes actually utilized by the air. **VELOCITY:** The actual velocity of the air through the vanes measured with a velometer or similar device.

DUCT Pt: The total pressure behind the register in the duct forcing that air through the register. **THROW:** The throws noted in the tables are the distance from the register to where the air stream velocity has dropped to not under 100/75/50 F.P.M.

NOISE CRITERIA: NC "A" scale. (1) Below NC25 extremely quiet. (2) Below NC30 Quiet Office. (3) Below NC35 Conference Rooms; normal voice 10-30 ft. (4) Below NC40 Conference Rooms; 6-12 ft. normal voice. (5) NC45 Conference Rooms; 3-6 ft. normal voice.

Engineering Data for SERIES Linear 1/2" Return Air Grilles

SIZE	Effective	Velocity	300	400	500	600	700	800	900	1000
Width In.	Area	Duct Ps	.006	.032	.048	.070	.092	.120	.130	.140
1 1/2	.140 ft ²	CFM/ft	42	56	70	84	98	112	126	140
2	.162 ft ²	CFM/ft	48	65	80	95	112	130	145	162
2 1/2	.207 ft ²	CFM/ft	60	85	105	125	145	165	185	207
3	.243 ft ²	CFM/ft	75	100	120	145	170	195	220	243
3 1/2	.270 ft ²	CFM/ft	80	105	135	160	190	215	245	270
4	.297 ft ²	CFM/ft	90	120	150	180	210	240	270	297
5	.360 ft ²	CFM/ft	110	145	180	215	250	290	325	360
6	.414 ft ²	CFM/ft	125	165	210	250	290	330	370	414
8	.513 ft ²	CFM/ft	155	205	255	310	360	410	460	513
10	.612 ft ²	CFM/ft	185	245	305	370	430	490	550	612
12	.702 ft ²	CFM/ft	210	280	350	420	490	560	630	702
14	.787 ft ²	CFM/ft	235	310	395	470	550	625	705	787

Note: All values in above table are per lineal foot.

Engineering Data for SERIES Linear 1/2" Supply Diffuser

SIZE/width	Velocity	300	400	500	600	700	800	900	1000
Eff.Area	Duct Pt	.006	.010	.015	.021	.029	.038	.048	.065
1 1/2	CFM/ft	16	21	27	32	37	42	48	53
.053 ft ²	Throw	3/3.5/4	4.5/5/5.5	5/5.5/6	6/7/8	7/8/9	8/9.5/11	8.5/10/12.5	
9.5/12/14.5	NC	<20	<20	<20	20	25	25-30	30-35	35
2	CFM/ft	29	38	48	57	67	76	86	95
.095 ft ²	Throw	4/4.5/5	5.5/6/6.5	7/8/9	8/9.5/11	10/11.5/13	10.5/12.5/14.5	12/15/18	13/17/20
	NC	<20	<20	<20	20	25	25-30	30-35	35
2 1/2	CFM/ft	35	46	58	70	81	93	104	116
.116 ft ²	Throw	5/5.5/6	6.5/7/7.5	8/9/10	8.5/10/11.5	10.5/12.5/14.5	11.5/13.5/16	13/17/20	14/18/22
	NC	<20	<20	<20	20	25	25-30	30-35	35
3	CFM/ft	48	63	79	95	111	126	142	158
.158 ft ²	Throw	5.5/6/6.5	7/8/9	9.5/10.5/11.5	10.5/12.5/14.5	13/15/17	14/17/19	16/20/23	17/22/26
	NC	<20	<20	<20	20	25	25-30	30-35	35
3 1/2	CFM/ft	55	74	92	110	142	147	166	184
.185 ft ²	Throw	6.5/7/7.5	8/9/10	10.5/11.5/12.5	11.5/13.5/16	14/17/19	15/18/21	17/21/25	18/23/27
	NC	<20	<20	20	20	25	30	35	40
4	CFM/ft	66	88	111	133	155	177	199	221
.221 ft ²	Throw	7/7.5/8.5	9.5/10.5/11.5	11.5/12.5/14	13/16/18	15/18/21	18/21/24	17/22/26	19/24/29
	NC	<20	<20	20	25	25	30	35	40
5	CFM/ft	87	116	145	173	202	231	260	289
.289 ft ²	Throw	8/9/10	10.5/11.5/12.5	13.5/15/17	14/17/19	17/20/22	19/23/26	20/26/31	23/29/34
	NC	<20	<20	20	25	30	30-35	35-40	40
6	CFM/ft	106	141	176	211	246	282	317	352
.352 ft ²	Throw	8.5/9.5/10.5	11.5/12.5/14	14/15.5/17	17/20/22	18/21/24	19/23/26	20/26/31	23/29/34
	NC	<20	<20	20	25	25-30	30	35-40	40
8	CFM/ft	145	193	242	290	338	386	435	483
.483 ft ²	Throw	10.5/11.5/12.5	13.5/15/17	15/17/18	18/21/24	22/26/29	24/29/33	26/33/40	30/38/45
	NC	<20	<20	20	25	30	30-35	35-40	40
10	CFM/ft	183	244	305	365	426	487	548	609
.609 ft ²	Throw	11.5/12.5/14	15/17/18	19/21/23	20/24/28	24/29/33	28/33/38	30/38/45	32/41/49
	NC	<20	20	25	25-30	30-35	30-35	40	45
12	CFM/ft	224	298	373	448	522	597	671	746
.746 ft ²	Throw	13.5/15/17	16/18/20	22/24/26	24/29/33	27/32/36	31/36/41	31/39/47	37/47/56
	NC	<20	20	25	30	35	35-40	40	45
14	CFM/ft	266	355	444	533	622	710	799	888
.888 ft ²	Throw	16/18/20	20/23/25	24/27/30	26/30/35	29/35/40	32/38/43	36/45/54	42/53/63
	NC	<20	20	25	30	35-40	40	45	45

This information is intended to provide product alternatives. Shoemaker will not assume any responsibility or guarantee that the products compared are equal in design or performance. It is the contractors responsibility to get approval on cross reference substitutions, inclusive of any options, before bidding.

SHOEMAKER MODEL	Catalog Pg.	AIRMATE	HART & COOLEY	LIMA / J & J	AMERIFLOW
100	5	1010	24	1100	RA2304
100D	5	1030	24-22	1102	RA2204
100OBD	5	N/A	24-23	1104	RA2104
SDD	6	1051-1054	AF	1100	2000
200	7	500/600	300's	501-504	360
200-O	7	T-500-0/T-600-O	N/A	N/A	N/A
90	6	800	16	150	1500
91	6	800-D	12	155	1800
92	6	800-R	11	N/A	1900
150	5	190	684	604	384
151	5	180	N/A	N/A	N/A
400	8	1100	N/A	1150	N/A
425	8	1020	N/A	N/A	N/A
450	9	1200	N/A	1170	N/A
452	9	N/A	N/A	N/A	N/A
TS	17	301	420	875	427
350	16	300	421	800	413
350T		N/A	N/A	N/A	456
350TCA		N/A	N/A	N/A	N/A
375	16	310	411	850	410
AFP	17	N/A	531	AL833	N/A
845	10	140	683	603	383
850	10	160	682	602	382
850-O	10	T-150-OB	N/A	N/A	N/A
833	10	N/A	661	653	356
875	14	350	406	470	3015/3018
945	11	N/A	N/A	N/A	N/A
951	11	220-V	A618MS	601 / 900V	192L
950 O	11	200-VO	N/A	900VO	N/A
955	14	N/A	N/A	N/A	N/A
1025		N/A	651	N/A	N/A
1050	12	170	672	60GH	372
A-1050	12	A-170	N/A	N/A	N/A
1075	12	N/A	N/A	N/A	N/A
FG	13	170FF	673	60GHFF	326
FG/AD	13	AD-1-FF	N/A	N/A	N/A
920FG	13	280FF	RHF45	S90HFF	N/A
855	14	N/A	664	N/A	367
1100	15	N/A	N/A	N/A	N/A
1150	15	174, 657	N/A	60GH7	N/A
1133	15	N/A	657	N/A	375
1550	18	325-O	210	830	400
1600	18	325	265	825	405

CONTINENTAL	TRU-AIR	METAL FAB	US AIRE	SHOEMAKER MODEL NUMBER AND GENERAL PRODUCT DISCRPTION
19	N/A	N/A	N/A	100 •4-way fixed blade step down diffuser
M-1000	500	N/A	N/A	100D •4-way diffuser w/ multi-blade parallel damper
19-18BD	500-O	N/A	N/A	100OBD •4-way diffuser with opposed blade damper
N/A	N/A	MFEASC	N/A	SDD -Square ceiling directional diffuser with flush core
MC	400	MFCSCR	1200M	200 •Curved blade sidewall/ceiling diffuser with damper
200-O	N/A	N/A	N/A	200-O •Curved blade diffuser with opposed blade damper
16	N/A	MFCD	900	90 •Step down curved blade round ceiling diffuser
12B	N/A	MFCDD	N/A	91 •Round butterfly damper
11	N/A	N/A	N/A	92 •Galvanized round ring
M24	104M	MFSCR-4	1104M	150 •4-way stamped 1/2" blade ceiling diffuser
MG-244	N/A	N/A	N/A	151 •4-way stamped grille only
N/A	600	N/A	N/A	400 •Step down 4-way swamp cooler diffuser
M1020	N/A	N/A	N/A	425 •Step down swamp cooler diffuser w/slide-in damper
M1200	700	N/A	N/A	450 •Flush mount 2-way swamp cooler diffuser
N/A	N/A	N/A	N/A	452 •2-way curved blade diffuser with slide-in damper
TG-32/TS285	N/A	MFTSG	1320	TS •2 1/4"-4" toe space grille
L28	N/A	MFFR	1500	350 •2 1/4"-4"-6" floor perimeter diffuser
L-30	N/A	N/A	N/A	350T •Stamped perimeter diffuser for mobile homes
L-305	N/A	N/A	N/A	350TCA •Stamped perimeter return air for mobile homes
P-28	N/A	N/A	N/A	375 •2 1/4"-4"-6" Deluxe floor register
N/A	N/A	N/A	N/A	AFP •Aluminum floor perimeter diffuser
M23	103M	MFSCR -3	1103M	845 •3-way stamped fan shaped louver sidewall register
M22	102M	MFSCR-2	1102M	850 •1/2" spaced 2-way stamped sidewall register
N/A	N/A	N/A	N/A	850-O •Sidewall register with opposed blade damper
M32	N/A	N/A	N/A	833 •1/3" spaced 2-way stamped sidewall register
180 / 240	N/A	MFB	1340	875 •Triangular baseboard diffuser
N/A	N/A	N/A	N/A	945 •Adj blade diffuser with 3 or 4-way air flow patterns
VML	210VM	MFSCRA	VM	951 •Sidewall/ceiling adjustable blade parallel damper diffuser
N/A	210VO	N/A	VD	950 O •Vertical multi-blade diffuser with opposed blade damper
N/A	N/A	N/A	N/A	955 • Baseboard register with multi-shutter damper
M51	N/A	N/A	N/A	1025 •Horizontal multi-shutter sidewall register
G-25	170	MFRG	1400	1050 •1/2" spaced sidewall/ceiling return air grille
N/A	N/A	N/A	N/A	A-1050 •Aluminum 1/2" spaced sidewall/ceiling return air grille
N/A	N/A	N/A	N/A	1075 •Sidewall/ceiling high velocity return air grille
FG-2	190	MFRFG	1410F	FG •Sidewall/ceiling stamped return air filter grille
DFG-2	N/A	N/A	1410AD	FG/AD •Stamped return air filter and access grille
N/A	N/A	N/A	RHEF	920FG • Fixed airfoil blade Ffilter grille
MB22	N/A	N/A	1300	855 •Louvered steel baseboard register w/parallel blade damper
N/A	N/A	N/A	N/A	1100 • Baseboard Return Air Grille
BG21	N/A	N/A	N/A	1150 •1/2" spaced, 7/8" baseboard return air grille
MB32	N/A	N/A	N/A	1133 •1/3" spaced, 7/8" baseboard return air grille
F-20	DR	N/A	N/A	1550 •Honeycomb construction fabricated floor supply register
F25	DSC	N/A	1530	1600 •Honeycomb construction fabricated floor return air grille

PRODUCT .. Engineering CATALOG SERIES #	PAGE	PAGE
90.....	E8.....	6
91.....		6
92.....		6
100.....	E4.....	5
150.....	E8.....	5
151.....		5
200.....	E5.....	7
350.....	E10.....	16
375.....	E11.....	16
400.....	E9.....	8
425.....	E9.....	8
450.....	E9.....	9
452.....	E8.....	9
833.....	E13.....	10
845.....	E12.....	10
850.....	E14.....	10

PRODUCT .. Engineering CATALOG SERIES #	PAGE	PAGE
855.....	E15.....	14
920FG.....	E20.....	13
945.....	E13.....	11
950 / 951.....	E18.....	11
955.....	E18.....	14
1050.....	E16-17.....	12
1075.....	E16-17.....	12
1100.....	E15.....	15
1133.....	E15.....	15
1150.....	E15.....	15
1550.....	E19.....	20
1560.....	E19.....	20
1600.....	E21.....	20
1610.....	E20.....	20
A1050.....	E17.....	12

PRODUCT .. Engineering CATALOG SERIES #	PAGE	PAGE
Accessories.....		24
AFG.....	E12.....	17
AFP.....	E12.....	17
AFP GG.....	E12.....	17
Brass.....	E10.....	21
Chrome.....	E10.....	21
Designer Colors.....	E10.....	21
FG.....	E20.....	13
FG/AD.....	E20.....	13
Linear (LF,LS,LSW).....	E24-25.....	18-19
No Labor Collar.....		24
Ornamental.....		23
SDD.....	E6-7.....	6
TS.....		17
Wood Oak.....	E22.....	22-23

• For product pricing refer to index on back page of current "Product Price List" catalog.

Glossary of Terms

REGISTER

A grille in combination with a device for controlling the quantity of air flow.

GRILLE

A device for covering an opening.

DIFFUSER

An air flow device which spreads the air in a circular or partially circular path in a thin stream along a wall, floor or ceiling.

THROW

The distance measured in feet that an air stream travels from the outlet to point of terminal velocity. Throw is measured horizontally from a register and vertically from perimeter diffusers.

SPREAD

The maximum total width in feet of the air pattern at the point of terminal velocity.

NOMINAL

Size given to opening or actual duct dimension in inches

DROP

The vertical distance the lower edge of a horizontally projected air stream drops between the outlet and the end of its throw.

CORE AREA

The area of the finned or louvered portion of the grille.

FREE AREA

The measured area through the vanes which the air sees.

EFFECTIVE AREA

The area determined by the manufacturer which shows the area that is used by the air passing through the diffuser or register. This value will always be less than the free area, because the air never fully utilizes the whole free area.

STATIC PRESSURE

The pressure in air or a gas due to the fact it has been compressed above the outside pressure. In a duct system it is the pressure which builds up before a restriction to give the energy to speed the air up past the obstruction and is measured in inches of water.

C.F.M.

A measure of the volume of air in cubic feet per minute.

NOISE CRITERIA (NC)

A sound rating in pressure level given in decibels. Based on established criteria and specific room acoustic absorption values. Catalogue NC ratings are based on 10db room attenuation, 10-12 watts with a 8db attenuation in all octave bands.

VELOCITY PRESSURE

The pressure developed when air or a gas that is moving has been brought to rest it is measured in inches of water.

TOTAL PRESSURE

The sum of the static and velocity pressures. A tube facing upstream in a duct will indicate the pressure due to the fact the air is moving and also that due to its being compressed in the duct, or it reads the total pressure in inches of water.

LATENT HEAT

Latent heat is the cooling load needed to remove the moisture from the air. The heat removed in taking the moisture from the air does not lower the temperature of the air.

SENSIBLE HEAT

Sensible heat is the heat required to change the temperature of the air. It is the cooling or heating effect that we actually feel or sense, hence the name sensible heat.

VELOCITY

The average velocity of air emerging from the outlet measured in the plane of the opening.

F.P.M.

A measure of the air velocity in feet per minute.

DAMPER OR VALVE

A device used to control the volume of air passing through a duct by varying the cross-sectional area.

JET VELOCITY

The average measured velocity of air passing between the